

Operating Instructions

Series L 4000 Spring Driven Cord Reels

L 4035 163 1	L 4545 123 3	L 4545 123 7A	L 4050 163 10
L 4050 163 1	L 4545 123 3-RP	L 4545 123 7B	L 4050 163 X
L 4035 162 2	L 4545 123 3A	L 4035 163 8	L 4545 123 X
L 4050 162 2	L 4545 123 3A-RP	L 4050 163 8	L 4000
L 4035 163 3	L 4545 123 3B	L 4050 163 9	L 4100
L 4035 163 3-RP	L 4035 A 163 5	L 4545 123 9	L 4500
L 4050 163 3	L 4050 A 163 5	L 4545 123 9G	
L 4050 163 3-RP	L 4545 123 7	L 4035 163 10	



Dimensions

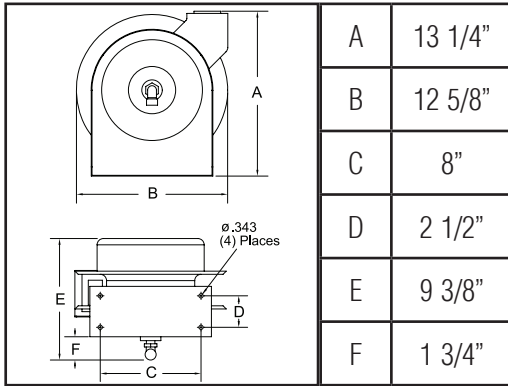

IMPORTANT

Read this manual carefully before installing, operating or servicing this equipment.

WARNING: Even low voltage can cause irreparable damage or death! Exercise extreme caution while operating or servicing this equipment.

Safety Precautions

Personal injury and/or equipment damage may result if proper safety precautions are not observed.

- Ensure that only a qualified electrician installs/services this equipment.
- Ensure that power supply voltage does not exceed maximum voltage rating of reel.
- Ensure that reel is properly installed before connecting to power supply.
- All cord reels with flying leads must be hard wired to ensure proper function.
- Ensure that all electrical power is removed from reel before servicing.
- A high-tension spring assembly is contained within the reel. Exercise extreme caution.
- Check for frayed and/or broken wires before each use. Pull electrical cord from reel by grasping the electrical cord itself, not the work device.
- If an electrical malfunction should occur, remove power from reel immediately.
- Ensure that reel, electrical cord, and equipment being serviced are properly grounded. Use an ohmmeter to check ground continuity.
- If reel ceases to unwind or rewind, remove power immediately. Do not pull or jerk on electrical cord!
- Treat and respect the reel as any other piece of machinery, observing all common safety practices.

Installation Instructions

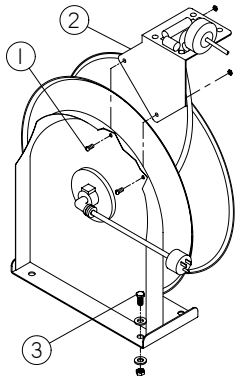

Mounting

CAUTION: Unless reel was specified differently when ordering, maximum installation height is 16 feet. Do not exceed this distance. Ensure that only a qualified electrician installs/services this equipment. Installation of GFCI cord reels should be performed by a qualified and licensed professional in accordance with building codes and applicable NEC standards.

1. Unpack and inspect reel for damage. Turn by hand to check for smooth operation. Check for completeness.
2. Configure reel for top, side or bottom-wind (bottom-wind for constant tension reels only) electrical cord dispensing by removing bolts (1), securing guide arm bracket (2). Determine new guide arm location and remove corresponding bolts. Position guide arm bracket to reel and replace bolts.
3. Position reel on floor, wall, or ceiling. Secure into place, using four (customer supplied) screws or bolts (3).

Form# 542-290 Rev: 2/2018

Installing the Input Electrical Cable

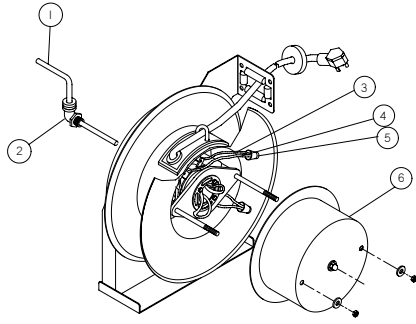

WARNING: Use only 12/3 or 16/3 cable for input wiring. Ensure that application does not exceed electrical rating of reel (refer to page 1 of this manual). All cord reels with GFCI receptacles must be hard wired into the electrical circuit. Use of 2 or 3 prong plugs may cause a potential malfunction of the GFCI receptacle.

1. Feed input cable (1) through elbow (2) and main shaft. Make sure that input cable extends 6" from collector.
2. Screw elbow (2) into reel.
3. Connect input wires (3) and collector ring wires (4) together using wire nuts (5).
4. Take the provided zip tie (not pictured) and zip tie the input cable wires together closest to the slip ring.
5. Assemble cover (6) to reel.

Installing the Output Electrical Cable

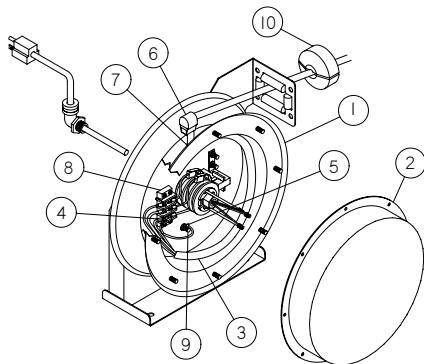

WARNING: Select output cable in accordance with power requirement of apparatus to be supplied. Ensure that application does not exceed electrical rating of reel (refer to page 1 of this manual). Use extreme caution, reel under tension. Avoid releasing latch mechanism.

1. Manually turn sheave (1) until spring is tight, back off 2 turns, and latch.

2. Remove access cover (2).
3. Remove 6" of output cable outer jacket (3) and add fork terminals (4) to ends.
4. Route cable through strain relief (6), then through cut out in spool (7).
5. Pull enough cable through for roughly 1/2 an inner wrap as shown in the diagram.
6. Connect output wires to terminal block (8) as shown.
7. Connect ground wire to grounding stud (9) as shown.
8. Using Ohmmeter check for ground faults.
9. Take provided cable clamp (not pictured) and attach it to the wire. Then take the cable clamp and screw it down to the brush assembly on the reel.
10. Replace cover (2).
11. Release latch and wind cable onto reel.
12. Install bumper stop (10).

Adjustments - Spring Tension

If necessary, adjust spring tension on reel by adding or removing wraps of electrical cord from spool, one wrap at a time, until desired tension is obtained. Add wraps to increase tension. Remove wraps to decrease tension.

WARNING: When adding wraps of electrical cord, be careful not to exceed the winding mechanism's spring capacity. Add just enough wraps of cord to achieve the desired tension. Damage to the winding mechanism will result if spring is over-tensioned. Always be aware of spring tension on reel. Exercise extreme caution.

Troubleshooting Instructions

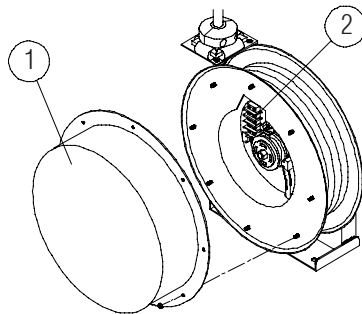

Troubleshooting of the reel consists of isolating a problem to a defective electrical cord/work device, brush holder/brushes, or collector assembly. Refer any other discrepancies only to an authorized service person or directly to Reelcraft.

WARNING: The following procedure directs the technician to take voltage measurements. Remember, even low voltage is dangerous and can cause personal injury or death. Exercise extreme caution! Ensure that only a qualified electrician installs/services this equipment.

1. If work device is either an incandescent or fluorescent light, replace bulb with a known good bulb. If this does not correct the problem, proceed to step 2. If work device is an electrical receptacle, ensure that tool or fixture connected to it is in good working order. If it is, proceed to step 2.
2. Remove power from reel.
3. Remove access cover (1).
4. Reapply power to reel.
5. Check for correct voltage (120 V AC) at terminal strip (2). If voltage reading is correct, replace output electrical cord/work device (refer to Service Instructions). If voltage reading is incorrect, proceed to step 6.
6. Remove power from reel.
7. Using ohmmeter, check continuity of input electrical cord. If cord checks good, proceed to step 8. If cord is faulty, replace it (refer to Service Instructions).
8. Remove brush holder/brushes from reel and inspect (refer to Service Instructions). Replace defective components then proceed to step 9.
9. Reapply power to reel.
10. Check for correct voltage (120 V AC) at terminal strip (2). If voltage reading is still incorrect, replace defective collector assembly (refer to Service Instructions).
11. Replace access cover (1).

Service Instructions

Maintain reel by following the service instructions given below. Refer all other repairs, other than those listed, only to an authorized service person or directly to Reelcraft. Failure to do so can result in personal injury and/or equipment damage and may void the warranty (refer to page 5 when referencing parts).

WARNING: Remove power from reel before performing any of the following procedures.

Replacing the Output Electrical Cord/Work Device

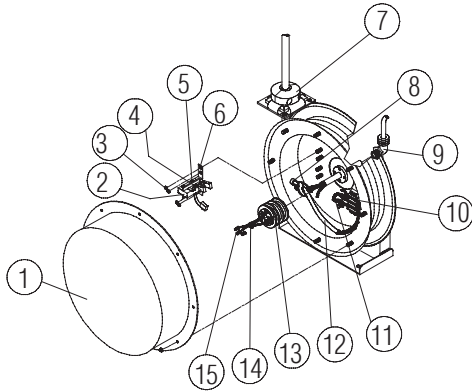

WARNING: Use extreme caution, reel under tension. Avoid releasing latch mechanism.

1. Pull output electrical cord from reel until fully extended, then latch.
2. Remove output electrical bumper stop (7).
3. Disconnect output electrical cord/work device (12) at terminal strip (10).
4. Remove strain relief (8). Remove output electrical cord/work device.
5. Install replacement electrical cord/work device by reversing steps 2 through 4.
6. Release latch and rewind electrical cord on reel.
7. Replace access cover (1).

Replacing the Input Electrical Cord

WARNING: Use of 2 or 3 prong plugs on cord reels equipped with GFCI receptacles may cause a potential malfunction of the GFCI receptacle.

1. Remove wire nuts (15) securing input electrical cord to collector assembly (13).
2. Remove 90 degree elbow (9).
3. Remove input electrical cord.
4. Remove 11" of outer jacket from replacement input electrical cord (input electrical cord wires must protrude a minimum of 6" from center of collector assembly).
5. Install replacement input electrical cord by reversing steps 1 through 3.
6. Replace access cover (1).

Replacing the Brush Holder/Brushes

1. At terminal strip (10), remove wires connecting brushes (11) to terminal strip.

2. Remove lock nuts (3) securing brush holder (6) to reel. Relocate cable clamp temporarily and remove brush holder.
3. Remove brushes (4) from brush holder (6).
4. Install replacement brush holder/brushes by reversing steps 1 through 3. Upon completion of installation, adjust brush-to-ring alignment by loosening nuts (5) and sliding finger assembly (2).

Replacing the Collector Assembly

1. Remove wire nuts (15) securing input electrical cord to collector assembly.
2. At terminal strip (10), disconnect wires (11) connecting brushes (4) to terminal strip.
3. Remove lock nuts (3) securing brush holder (6) to reel. Relocate cable clamp temporarily and remove brush holder.
4. Remove snap ring (14).
5. Remove collector assembly (13).
6. Install replacement collector assembly by reversing steps 1 through 5. Upon completion of installation, adjust brush-to-ring alignment by loosening nuts (5) and sliding finger assembly (2).
7. Replace access cover (1).

Autoswitch Operating Instructions

To operate Autoswitch reels, pull out and retract cable as shown in the above diagram. When cable is fully retracted, the reel is in the "Off" position. As the cable is pulled out, the guide arm pivots upward and the reel switches to the "On" position.

Autoswitch Troubleshooting Service Instructions

Maintain reel by following the service instructions given below. Refer all other repairs, other than those listed, only to an authorized service person or directly to Reelcraft. Failure to do so can result in personal injury and/or equipment damage and may void the warranty. If reel fails to operate electrically, refer to troubleshooting instructions on page 2. If problem persists, check switch using the following steps.

1. Using an ohmmeter, check for continuity between lines (1) and (2), while switch is in the "On" or "Up" position.
2. If continuity test fails, replace switch (3).

3. If continuity test passes, check for inlet cord (4) damage.

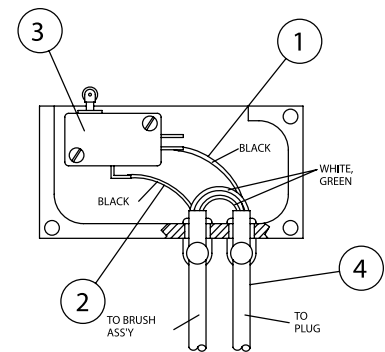
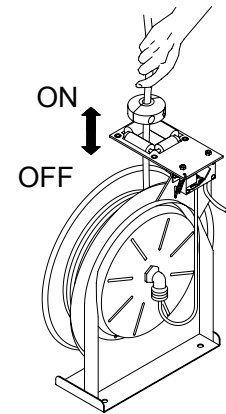

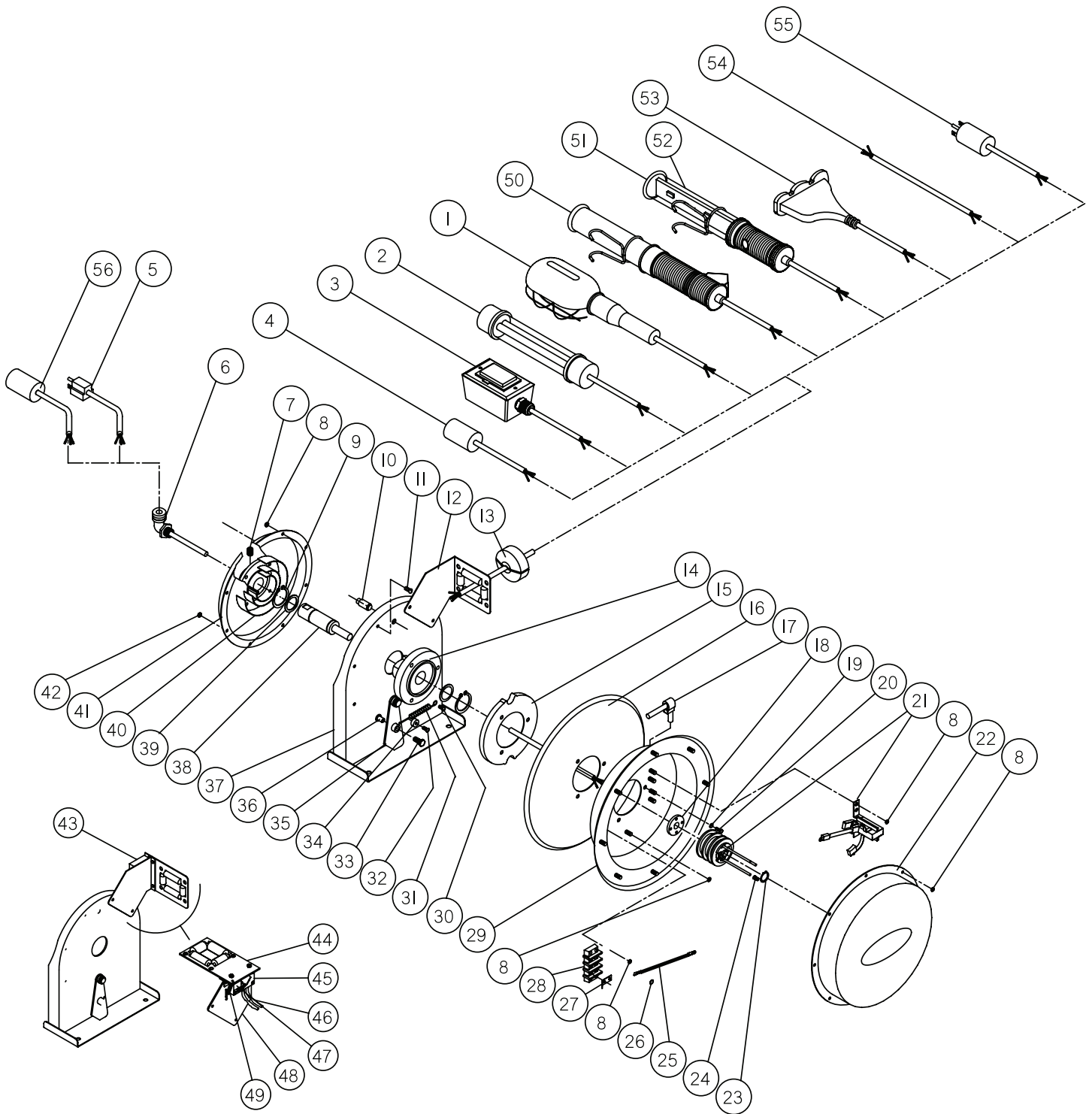

Series L 4000 Spring Driven Cord Reels

Item #	Description	# Req.	L 4035 163 1	L 4050 163 1	L 4035 162 2	L 4050 162 2	L 4035 163 3	L 4050 163 3	L 4545 123 3
1	Incandescent Lamp/Cord Assembly	1	600223	600212	None	None	None	None	None
2	Fluorescent Lamp/Cord Assembly	1	None	None	600207	600211	None	None	None
3	Duplex GFCI Box/Cord Assembly	1	None	None	None	None	None	None	None
4	Single Outlet	1	None	None	None	None	600208	600209	600251
5	Inlet Cord Assembly	1	260517	260517	600213	600213	260517	260517	260630
6	Connector, 90° Cord	1	261140-1-C	261140-1-C	261140-1-C	261140-1-C	261140-1-C	261140-1-C	261140-C
7	Screw, Set 3/8-19 x 1/2" Pin	1	300006	300006	300006	300006	300006	300006	300006
8	Nut, Lock 10-32 Hex	22	S300011	S300011	S300011	S300011	S300011	S300011	S300011
9	Snap Ring	1	300031	300031	300031	300031	300031	300031	300031
10	Stud, Springcase	1	S261360	S261360	S261360	S261360	S261360	S261360	S261360
11	Screw, 10-32 x 1/2"	2	300002	300002	300002	300002	300002	300002	300002
12	Guide Arm Assembly	1	S400107	S400107	S400107	S400107	S400107	S400107	S400107
13	Bumper Assembly	1	600193	600193	600193	600193	600193	600193	1-HR1004-A
14	Spring Arbor	1	S400017	S400017	S400017	S400017	S400017	S400017	S400017
15	Latch Cam	1	S400019	S400019	S400019	S400019	S400019	S400019	S400019
16	Sheave Disc	1	400006	400006	400006	400006	400006	400006	400006
17	Strain Relief	1	260501	260501	260501	260501	260501	260501	260633
18	Adapter, Plate	1	261577	261577	261577	261577	261577	261577	261577
19	Split Lock Washer	3	902016	902016	902016	902016	902016	902016	902016
20	Screw, 1/4-20 x 5/8" Hex	3	S2-42	S2-42	S2-42	S2-42	S2-42	S2-42	S2-42
21	Collector Ring Assembly	1	602296	602296	602296	602296	602296	602296	602296
22	Cover	1	261723	261723	261723	261723	261723	261723	261723
23	Snap Ring	1	S140-13	S140-13	S140-13	S140-13	S140-13	S140-13	S140-13
24	Wire Nut	3	260500	260500	260500	260500	260500	260500	260774
25	Grounding Cord Assembly	1	600241	600241	600241	600241	600241	600241	600283
26	Lock Washer	1	S115-10	S115-10	S115-10	S115-10	S115-10	S115-10	S115-10
27	Connect Terminal	1	260609	260609	260609	260609	260609	260609	260609
28	Terminal Block Assembly	1	600205	600205	600205	600205	600205	600205	600205
29	Sheave Assembly	1	600194	600194	600194	600194	600194	600194	600254
30	Screw, 10-32 x 3/8"	5	300001	300001	300001	300001	300001	300001	300001
31	Latch Plate Spring	1	S400018	S400018	S400018	S400018	S400018	S400018	S400018
32	Screw, 10-24 x 3/8"	1	S32-136	S32-136	S32-136	S32-136	S32-136	S32-136	S32-136
33	Screw 10-32 x 1"	1	300035	300035	300035	300035	300035	300035	300035
34	Latch Bumper	1	S400021	S400021	S400021	S400021	S400021	S400021	S400021
35	Latch Plate Assembly	1	S400109	S400109	S400109	S400109	S400109	S400109	S400109
36	Latch Bushing	1	S400012	S400012	S400012	S400012	S400012	S400012	S400012
37	Base Assembly	1	400101	400101	400101	400101	400101	400101	400101
38	Main Shaft Kit	1	602348	602348	602348	602348	602348	602348	602348
39	Spacing Washer	2	300034	300034	300034	300034	300034	300034	300034
40	Drive Spring Assembly	1	S400030	S400030	S400030	S400030	S400030	S400030	S400030
41	Spring Case Assembly	1	S400103	S400103	S400103	S400103	S400103	S400103	S400103
42	Nut, 10-32 x 3/8" Nyloc	1	S82-15	S82-15	S82-15	S82-15	S82-15	S82-15	S82-15
43	Guide Arm Switch Assembly	1	None	None	None	None	None	None	None
44	Roller Plate Assembly	1	None	None	None	None	None	None	None
45	Switch Box	1	None	None	None	None	None	None	None
46	Autoswitch Cord	1	None	None	None	None	None	None	None
47	Switch	1	None	None	None	None	None	None	None
48	Guide Arm	1	None	None	None	None	None	None	None
49	Spring	1	None	None	None	None	None	None	None
50	Fluorescent Lamp & Single Outlet	1	None	None	None	None	None	None	None
51	LED Lamp/Cord Assembly	1	None	None	None	None	None	None	None
52	Polycarbonate Tube Assembly	1	None	None	None	None	None	None	None
53	Triple Tap/Cord Assembly	1	None	None	None	None	None	None	None
54	Flying Leads	1	None	None	None	None	None	None	None
55	Outlet Cord Assembly w/ Plug	1	None	None	None	None	None	None	None
56	Inlet Cord Assembly	1	None	None	None	None	None	None	None

Series L 4000 Spring Driven Cord Reels

Item #	Description	# Req.	L 4545 123 3A	L 4545 123 3B	L 4035 A 163 5	L 4050 A 163 5	L 4545 123 7	L 4545 123 7A	L 4545 123 7B
1	Incandescent Lamp/Cord Assembly	1	None	None	600458-35	600458-50	None	None	None
2	Fluorescent Lamp/Cord Assembly	1	None	None	None	None	None	None	None
3	Duplex GFCI Box/Cord Assembly	1	None	None	None	None	602332-45	602333-45	602255-45
4	Single Outlet	1	602003	602004	None	None	None	None	None
5	Inlet Cord Assembly	1	602002	602002	600472	600472	260630	602002	602002
6	Connector, 90° Cord	1	S261140-C	S261140-C	S261140-1-C	S261140-1-C	S261140-C	S261140-C	S261140-C
7	Screw, Set 3/8-19 x 1/2" Pin	1	300006	300006	300006	300006	300006	300006	300006
8	Nut, Lock 10-32 Hex	22	S300011	S300011	S300011	S300011	S300011	S300011	S300011
9	Snap Ring	1	300031	300031	300031	300031	300031	300031	300031
10	Stud, Springcase	1	S261360	S261360	S261360	S261360	S261360	S261360	S261360
11	Screw, 10-32 x 1/2"	2	300002	300002	300002	300002	300002	300002	300002
12	Guide Arm Assembly	1	S400107	S400107	600341	600341	S400107	S400107	S400107
13	Bumper Assembly	1	1-HR1004-A	1-HR1004-A	600193	600193	1-HR1004-A	1-HR1004-A	1-HR1004-A
14	Spring Arbor	1	400017	400017	400017	400017	400017	400017	400017
15	Latch Cam	1	S400019	S400019	S400019	S400019	S400019	S400019	S400019
16	Sheave Disc	1	400006	400006	400006	400006	400006	400006	400006
17	Strain Relief	1	260633	260633	260501	260501	260633	260633	260633
18	Adapter, Plate	1	261577	261577	261577	261577	261577	261577	261577
19	Split Lock Washer	3	902016	902016	902016	902016	902016	902016	902016
20	Screw, 1/4-20 x 5/8" Hex	3	S2-42	S2-42	S2-42	S2-42	S2-42	S2-42	S2-42
21	Collector Ring Assembly	1	602296	602296	602296	602296	602296	602296	602296
22	Cover	1	261723	261723	261723	261723	261723	261723	261723
23	Snap Ring	1	S140-13	S140-13	S140-13	S140-13	S140-13	S140-13	S140-13
24	Wire Nut	3	260774	260774	260500	260500	260774	260774	260774
25	Grounding Cord Assembly	1	600283	600283	600241	600241	600283	600283	600283
26	Lock Washer	1	S115-10	S115-10	S115-10	S115-10	S115-10	S115-10	S115-10
27	Connect Terminal	1	260609	260609	260609	260609	260609	260609	260609
28	Terminal Block Assembly	1	600205	600205	600205	600205	600205	600205	600205
29	Sheave Assembly	1	600254	600254	600194	600194	600254	600254	600254
30	Screw, 10-32 x 3/8"	5	300001	300001	300001	300001	300001	300001	300001
31	Latch Plate Spring	1	S400018	S400018	S400018	S400018	S400018	S400018	S400018
32	Screw, 10-24 x 3/8"	1	S32-136	S32-136	S32-136	S32-136	S32-136	S32-136	S32-136
33	Screw 10-32 x 1"	1	300035	300035	300035	300035	300035	300035	300035
34	Latch Bumper	1	S400021	S400021	S400021	S400021	S400021	S400021	S400021
35	Latch Plate Assembly	1	S400109	S400109	S400109	S400109	S400109	S400109	S400109
36	Latch Bushing	1	S400012	S400012	S400012	S400012	S400012	S400012	S400012
37	Base Assembly	1	400101	400101	400101	400101	400101	400101	400101
38	Main Shaft Kit	1	602348	602348	602348	602348	602348	602348	602348
39	Spacing Washer	2	300034	300034	300034	300034	300034	300034	300034
40	Drive Spring Assembly	1	S400030	S400030	S400030	S400030	S400030	S400030	S400030
41	Spring Case Assembly	1	S400103	S400103	S400103	S400103	S400103	S400103	S400103
42	Nut, 10-32 x 3/8" Nyloc	1	S82-15	S82-15	S82-15	S82-15	S82-15	S82-15	S82-15
43	Guide Arm Switch Assembly	1	None	None	600341	600341	None	None	None
44	Roller Plate Assembly	1	None	None	600342	600342	None	None	None
45	Switch Box	1	None	None	260780	260780	None	None	None
46	Autoswitch Cord	1	None	None	600472	600472	None	None	None
47	Switch	1	None	None	260775	260775	None	None	None
48	Guide Arm	1	None	None	260778	260778	None	None	None
49	Spring	1	None	None	260779	260779	None	None	None
50	Fluorescent Lamp & Single Outlet	1	None	None	None	None	None	None	None
51	LED Lamp/Cord Assembly	1	None	None	None	None	None	None	None
52	Polycarbonate Tube Assembly	1	None	None	None	None	None	None	None
53	Triple Tap/Cord Assembly	1	None	None	None	None	None	None	None
54	Flying Leads	1	None	None	None	None	None	None	None
55	Outlet Cord Assembly w/ Plug	1	None	None	None	None	None	None	None
56	Inlet Cord Assembly	1	None	None	None	None	None	None	None

Series L 4000 Spring Driven Cord Reels

Item #	Description	# Req.	L 4035 163 8	L 4050 163 8	L 4050 163 9	L 4545 123 9	L 4545 123 9G	L 4035 163 10	L 4050 163 10	L 4050 163 X
1	Incandescent Lamp/Cord Assembly	1	None	None	None	None	None	None	None	None
2	Fluorescent Lamp/Cord Assembly	1	None	None	None	None	None	None	None	None
3	Duplex Box/Cord Assembly	1	None	None	None	None	None	None	None	None
4	Single Outlet	1	None	None	None	None	None	None	None	None
5	Inlet Cord Assembly	1	260517	260517	260517	260630	260630	260517	260517	262306
6	Connector, 90° Cord	1	261140-1-C	261140-1-C	261140-1-C	S261140	S261140	261140-1-C	261140-1-C	None
7	Screw, Set 3/8-19 x 1/2" Pin	1	300006	300006	300006	300006	300006	300006	300006	300006
8	Nut, Lock 10-32 Hex	22	S300011	S300011	S300011	S300011	S300011	S300011	S300011	S300011
9	Snap Ring	1	300031	300031	300031	300031	300031	300031	300031	300031
10	Stud, Springcase	1	S261360	S261360	S261360	S261360	S261360	S261360	S261360	S261360
11	Screw, 10-32 x 1/2"	2	300002	300002	300002	300002	300002	300002	300002	300002
12	Guide Arm Assembly	1	S400107	S400107	S400107	S400107	S400107	S400107	S400107	S400107
13	Bumper Assembly	1	600193	600193	600193	1-HR1004-A	1-HR1004-A	600193	600193	600193
14	Spring Arbor	1	S400017	S400017	S400017	S400017	S400017	S400017	S400017	S400017
15	Latch Cam	1	S400019	S400019	S400019	S400019	S400019	S400019	S400019	S400019
16	Sheave Disc	1	400006	400006	400006	400006	400006	400006	400006	400006
17	Strain Relief	1	260501	260501	260501	260633	260633	260501	260501	260501
18	Adapter, Plate	1	261577	261577	261577	261577	261577	261577	261577	261577
19	Split Lock Washer	3	902016	902016	902016	902016	902016	902016	902016	902016
20	Screw, 1/4-20 x 5/8" Hex	3	S2-42	S2-42	S2-42	S2-42	S2-42	S2-42	S2-42	S2-42
21	Collector Ring Assembly	1	602296	602296	602296	602296	602296	602296	602296	602296
22	Cover	1	261723	261723	261723	261723	261723	261723	261723	261723
23	Snap Ring	1	S140-13	S140-13	S140-13	S140-13	S140-13	S140-13	S140-13	S140-13
24	Wire Nut	3	260500	260500	260500	260774	260774	260500	260500	260500
25	Grounding Cord Assembly	1	600241	600241	600241	600283	600283	600241	600241	600241
26	Lock Washer	1	S115-10	S115-10	S115-10	S115-10	S115-10	S115-10	S115-10	S115-10
27	Connect Terminal	1	260609	260609	260609	260609	260609	260609	260609	260609
28	Terminal Block Assembly	1	600205	600205	600205	600205	600205	600205	600205	600205
29	Sheave Assembly	1	600194	600194	600194	600254	600254	600194	600194	600194
30	Screw, 10-32 x 3/8"	5	300001	300001	300001	300001	300001	300001	300001	300001
31	Latch Plate Spring	1	S400018	S400018	S400018	S400018	S400018	S400018	400018	400018
32	Screw, 10-24 x 3/8"	1	S32-136	S32-136	S32-136	S32-136	S32-136	S32-136	S32-136	S32-136
33	Screw 10-32 x 1"	1	300035	300035	300035	300035	300035	300035	300035	300035
34	Latch Bumper	1	S400021	S400021	S400021	S400021	S400021	S400021	S400021	S400021
35	Latch Plate Assembly	1	S400109	S400109	S400109	S400109	S400109	S400109	S400109	S400109
36	Latch Bushing	1	S400012	S400012	S400012	S400012	S400012	S400012	S400012	S400012
37	Base Assembly	1	400101	400101	400101	400101	400101	400101	400101	400101
38	Main Shaft Kit	1	602348	602348	602348	602348	602348	602348	602348	602348
39	Spacing Washer	2	300034	300034	300034	300034	300034	300034	300034	300034
40	Drive Spring Assembly	1	S400030	S400030	S400030	S400030	S400030	S400030	S400030	S400030
41	Spring Case Assembly	1	S400103	S400103	S400103	S400103	S400103	S400103	S400103	S400103
42	Nut, 10-32 x 3/8" Nyloc	1	S82-15	S82-15	S82-15	S82-15	S82-15	S82-15	S82-15	S82-15
43	Guide Arm Switch Assembly	1	None	None	None	None	None	None	None	None
44	Roller Plate Assembly	1	None	None	None	None	None	None	None	None
45	Switch Box	1	None	None	None	None	None	None	None	None
46	Autoswitch Cord	1	None	None	None	None	None	None	None	None
47	Switch	1	None	None	None	None	None	None	None	None
48	Guide Arm	1	None	None	None	None	None	None	None	None
49	Spring	1	None	None	None	None	None	None	None	None
50	Fluorescent Lamp & Single Outlet	1	602015-35	602015-50	None	None	None	None	None	None
51	LED Lamp/Cord Assembly	1	None	None	None	None	None	602473-35	602473-50	None
52	Polycarbonate Tube Assembly	1	None	None	None	None	None	S602729	S602729	None
53	Triple Tap/Cord Assembly	1	None	None	602496	602498	602497	None	None	None
54	Flying Leads	1	None	None	None	None	None	None	None	260952-50
55	Outlet Cord Assembly w/ Plug	1	None	None	None	None	None	None	None	None
56	Inlet Cord Assembly	1	None	None	None	None	None	None	None	None

Series L 4000 Spring Driven Cord Reels

Item #	Description	# Req.	L 4545 123 X	L 4000	L 4100	L 4500	L 4035 163 3-RP	L 4050 163 3-RP	L 4545 123 3-RP	L 4545 123 3A-RP
1	Incandescent Lamp/Cord Assembly	1	None	None	None	None	None	None	None	None
2	Fluorescent Lamp/Cord Assembly	1	None	None	None	None	None	None	None	None
3	Duplex GFCI Box/Cord Assembly	1	None	None	None	None	None	None	None	None
4	Single Outlet	1	None	None	None	None	None	None	None	None
5	Inlet Cord Assembly	1	262307	None	None	None	None	None	None	None
6	Connector, 90° Cord	1	None	261140-1-C	261140-1-C	S261140	261140-1-C	261140-1-C	261140-C	261140-C
7	Screw, Set 3/8-19 x 1/2" Pin	1	300006	300006	300006	300006	300006	300006	300006	300006
8	Nut, Lock 10-32 Hex	22	S300011	S300011	S300011	S300011	S300011	S300011	S300011	S300011
9	Snap Ring	1	300031	300031	300031	300031	300031	300031	300031	300031
10	Stud, Springcase	1	S261360	S261360	S261360	S261360	S261360	S261360	S261360	S261360
11	Screw, 10-32 x 1/2"	2	300002	300002	300002	300002	300002	300002	300002	300002
12	Guide Arm Assembly	1	S400107	S400107	S400107	S400107	S400107	S400107	S400107	S400107
13	Bumper Assembly	1	1-HR1004-A	None	None	None	600193	600193	1-HR1004-A	1-HR1004-A
14	Spring Arbor	1	S400017	S400017	S400017	S400017	S400017	S400017	S400017	S400017
15	Latch Cam	1	S400019	S400019	S400019	S400019	S400019	S400019	S400019	S400019
16	Sheave Disc	1	400006	400006	400006	400006	400006	400006	400006	400006
17	Strain Relief	1	260633	260501	260633	260633	260501	260501	260633	260633
18	Adapter, Plate	1	261577	261577	261577	261577	261577	261577	261577	261577
19	Split Lock Washer	3	902016	902016	902016	902016	902016	902016	902016	902016
20	Screw, 1/4-20 x 5/8" Hex	3	S2-42	S2-42	S2-42	S2-42	S2-42	S2-42	S2-42	S2-42
21	Collector Ring Assembly	1	602296	602296	602297	602296	602296	602296	602296	602296
22	Cover	1	261723	261723	261723	261723	261723	261723	261723	261723
23	Snap Ring	1	S140-13	S140-13	S140-13	S140-13	S140-13	S140-13	S140-13	S140-13
24	Wire Nut	3	260774	260500	260500	260774	260500	260500	260774	260774
25	Grounding Cord Assembly	1	600283	600241	600241	600283	600241	600241	600283	600283
26	Lock Washer	1	S115-10	S115-10	S115-10	S115-10	S115-10	S115-10	S115-10	S115-10
27	Connect Terminal	1	260609	260609	260609	260609	260609	260609	260609	260609
28	Terminal Block Assembly	1	600205	600205	600280	600205	600205	600205	600205	600205
29	Sheave Assembly	1	600254	600194	600278	600254	600194	600194	600254	600254
30	Screw, 10-32 x 3/8"	5	300001	300001	300001	300001	300001	300001	300001	300001
31	Latch Plate Spring	1	400018	400018	400018	400018	S400018	S400018	S400018	S400018
32	Screw, 10-24 x 3/8"	1	S32-136	S32-136	S32-136	S32-136	S32-136	S32-136	S32-136	S32-136
33	Screw 10-32 x 1"	1	300035	300035	300035	300035	300035	300035	300035	300035
34	Latch Bumper	1	S400021	S400021	S400021	S400021	S400021	S400021	S400021	S400021
35	Latch Plate Assembly	1	S400109	S400109	S400109	S400109	S400109	S400109	S400109	S400109
36	Latch Bushing	1	S400012	S400012	S400012	S400012	S400012	S400012	S400012	S400012
37	Base Assembly	1	400101	400101	400101	400101	400101	400101	400101	400101
38	Main Shaft Kit	1	602348	602348	602349	602348	602348	602348	602348	602348
39	Spacing Washer	2	300034	300034	300034	300034	300034	300034	300034	300034
40	Drive Spring Assembly	1	S400030	S400030	S400030	S400030	S400030	S400030	S400030	S400030
41	Spring Case Assembly	1	S400103	S400103	S400103	S400103	S400103	S400103	S400103	S400103
42	Nut, 10-32 x 3/8" Nyloc	1	S82-15	S82-15	S82-15	S82-15	S82-15	S82-15	S82-15	S82-15
43	Guide Arm Switch Assembly	1	None	None	None	None	None	None	None	None
44	Roller Plate Assembly	1	None	None	None	None	None	None	None	None
45	Switch Box	1	None	None	None	None	None	None	None	None
46	Autoswitch Cord	1	None	None	None	None	None	None	None	None
47	Switch	1	None	None	None	None	None	None	None	None
48	Guide Arm	1	None	None	None	None	None	None	None	None
49	Spring	1	None	None	None	None	None	None	None	None
50	Fluorescent Lamp & Single Outlet	1	None	None	None	None	None	None	None	None
51	LED Lamp/Cord Assembly	1	None	None	None	None	None	None	None	None
52	Polycarbonate Tube Assembly	1	None	None	None	None	None	None	None	None
53	Triple Tap/Cord Assembly	1	None	None	None	None	None	None	None	None
54	Flying Leads	1	602353-45	None	None	None	None	None	None	None
55	Outlet Cord Assembly w/ Plug	1	None	None	None	None	602626-35	602626-50	602644	602629
56	Inlet Cord Assembly	1	None	None	None	None	602643	602643	602627	602628