

LDM5 (Standard) & LDP5 (Preset) Electronic Metered Dispense Valves

312668Z
EN

For metered dispense of oils and antifreeze. For professional use only.
Not approved for use in European explosive atmosphere locations.

Models: See page 2

1000 psi (7 MPa, 69 bar) Maximum Working Pressure
5 gpm (19 lpm) Maximum Flow Rate



Important Safety Instructions

Read all warnings and instructions in this manual.
Save these instructions.

NOTICE

This dispense valve:

- must be calibrated upon installation (see pages 12 and 19). Dispense amounts will vary with fluid pressure, temperature, and type of fluid being dispensed.
- is designed to dispense petroleum-based lubricants and antifreeze only. Do not dispense windshield washer solvent with this dispense valve.
- is designed for indoor use only.
- is **not** designed for in-line installation.
- is designed for use with industrial grade batteries, (see page 31).

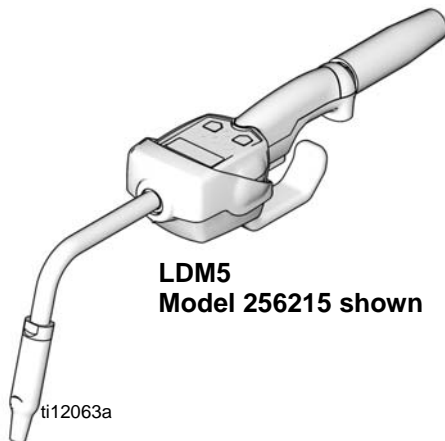

LDM5
Model 256215 shown

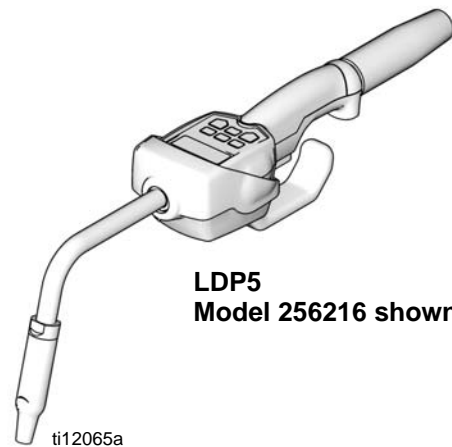

LDP5
Model 256216 shown







Models

Meter	Model No.	Extension		Impact Guard	Swivel Cover	Inlet		
		Rigid	Flex			NPT	BSPT	BSPP
LDM5	255751		X			X		
LDM5	256215	X		X	X	X		
LDM5	258693		X	X	X	X		
LDM5	24F881		X				X	
LDM5	24F882	X		X	X		X	
LDM5	24F885		X	X	X		X	
LDM5	24F887		X					X
LDM5	24F888	X		X	X			X
LDM5	24F891		X	X	X			X
LDP5	255277		X			X		
LDP5	256216	X		X	X	X		
LDP5	258694		X	X	X	X		
LDP5	24F883		X				X	
LDP5	24F884	X		X	X		X	
LDP5	24F886		X	X	X		X	
LDP5	24F889		X					X
LDP5	24F890	X		X	X			X
LDP5	24F892		X	X	X			X
LDP5	24X465			X	X			X

Warnings

The following warnings are for the setup, use, grounding, maintenance, and repair of this equipment. The exclamation point symbol alerts you to a general warning and the hazard symbol refers to procedure-specific risk. Refer back to these warnings. Additional, product-specific warnings may be found throughout the body of this manual where applicable.

 WARNING	
	<p>SKIN INJECTION HAZARD</p> <p>High-pressure fluid from dispense valve, hose leaks, or ruptured components will pierce skin. This may look like just a cut, but it is a serious injury that can result in amputation. Get immediate surgical treatment.</p> <ul style="list-style-type: none"> • Do not point dispense valve at anyone or at any part of the body. • Do not put your hand over the end of the dispense nozzle. • Do not stop or deflect leaks with your hand, body, glove, or rag. • Follow Pressure Relief Procedure in this manual, when you stop spraying and before cleaning, checking, or servicing equipment.
	<p>EQUIPMENT MISUSE HAZARD</p> <p>Misuse can cause death or serious injury.</p> <ul style="list-style-type: none"> • Do not operate the unit when fatigued or under the influence of drugs or alcohol. • Do not exceed the maximum working pressure or temperature rating of the lowest rated system component. See Technical Data in all equipment manuals. • Use fluids and solvents that are compatible with equipment wetted parts. See Technical Data in all equipment manuals. Read fluid and solvent manufacturer's warnings. For complete information about your material, request MSDS forms from distributor or retailer. • Check equipment daily. Repair or replace worn or damaged parts immediately with genuine manufacturer's replacement parts only. • Do not alter or modify equipment. • Use equipment only for its intended purpose. Call your distributor for information. • Route hoses and cables away from traffic areas, sharp edges, moving parts, and hot surfaces. • Do not kink or over bend hoses or use hoses to pull equipment. • Keep children and animals away from work area. • Comply with all applicable safety regulations.
	<p>FIRE AND EXPLOSION HAZARD</p> <p>When flammable fluids are present in the work area, such as gasoline and windshield wiper fluid, be aware that flammable fumes can ignite or explode. To help prevent fire and explosion:</p> <ul style="list-style-type: none"> • Use equipment only in well ventilated area. • Eliminate all ignition sources, such as cigarettes and portable electric lamps. • Keep work area free of debris, including rags and spilled or open containers of solvent and gasoline. • Do not plug or unplug power cords or turn lights on or off when flammable fumes are present. • Ground all equipment in the work area. • Use only grounded hoses. • If there is static sparking or you feel a shock, stop operation immediately. Do not use equipment until you identify and correct the problem. • Keep a working fire extinguisher in the work area.

 **WARNING**



PERSONAL PROTECTIVE EQUIPMENT

Wear appropriate protective equipment when in the work area to help prevent serious injury, including eye injury, hearing loss, inhalation of toxic fumes, and burns. Protective equipment includes but is not limited to:

- Protective eyewear, and hearing protection.
- Respirators, protective clothing, and gloves as recommended by the fluid and solvent manufacturer.

CALIFORNIA PROPOSITION 65

This product contains a chemical known to the State of California to cause cancer, birth defects or other reproductive harm. Wash hands after handling.

Installation

Typical Installations

FIG. 1 shows a typical hose reel installation. Dispense valves can also be installed on a console as shown in Fig. 2.

The typical installation shown in Fig. 1 is only a guide. It is not a complete system design. Contact your Graco distributor for assistance in designing a system to suit your needs.

KEY DESCRIPTION

- A Metered dispense valve
- B Fluid shut-off valve
- C Hose
- D Hose reel fluid inlet hose
- E Hose reel

A Thermal Relief Kit (not shown) is required. The kit will vary by pump selected. See Parts, page 28 for a list of available kits.

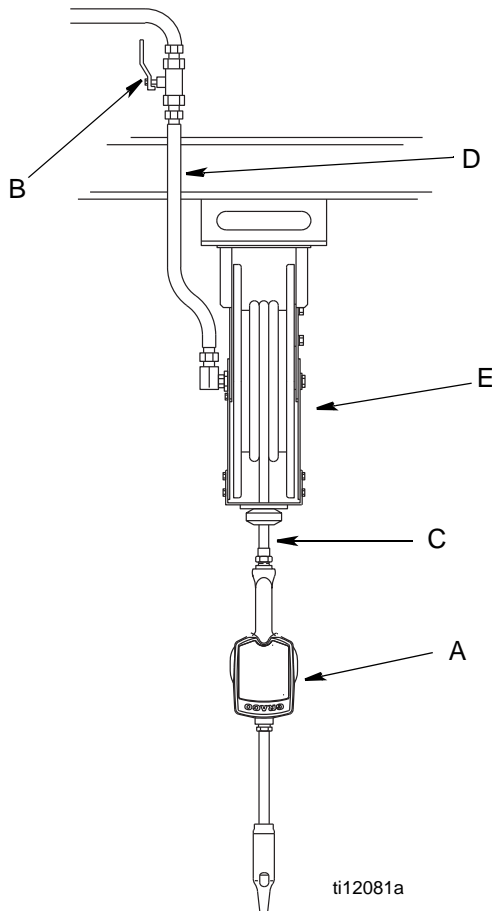

FIG. 1

NOTICE

- Do not use this dispense valve on non-Graco consoles. The trigger could be inadvertently pressed while the dispense valve is stowed.
- This dispense valve is not designed for in-line installation. Do not install with a shut-off valve on the outlet side of the meter which could damage the meter housing cover.

Mounting Bracket

Mounting bracket 196471 is available for resting dispense valve on a console. See Fig. 2.

NOTICE

Do not obstruct the dispense valve trigger and do not set the unit down resting on its trigger or it might not stop dispensing.

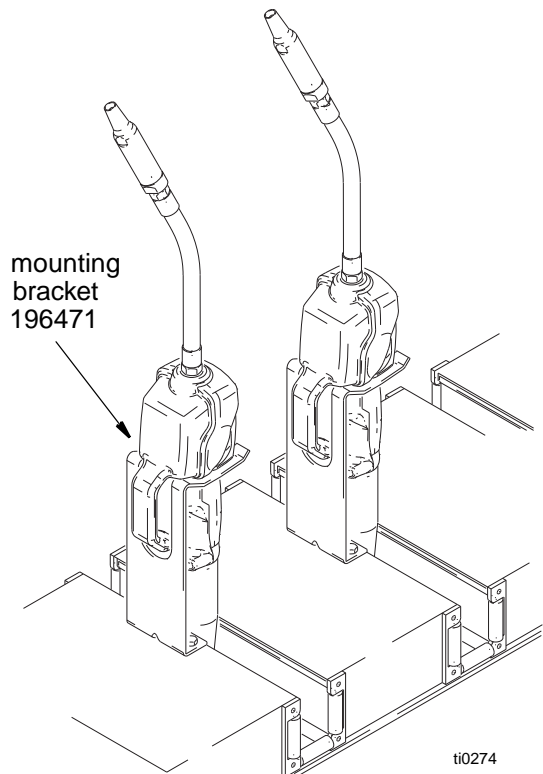
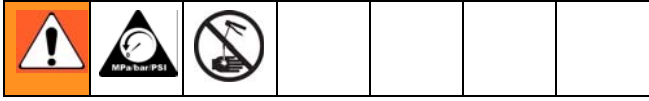

FIG. 2

Pressure Relief Procedure



The equipment stays pressurized until pressure is manually relieved. To reduce the risk of serious injury from pressurized fluid, accidental spray from the dispense valve, or splashing fluid, follow this **Pressure Relief Procedure** when you:

- are instructed to relieve pressure.
 - check, clean, or service any system equipment.
 - install or clean fluid nozzles or filter.
1. Turn off the power supply to the pump.
 2. Trigger the dispense valve into a waste container to relieve pressure.
 3. Open any bleed-type master air valves and fluid drain valves in the system.
 4. Leave the drain valve open until you are ready to pressurize the system.

Grounding

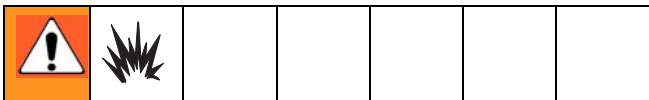

Proper grounding is an essential part of maintaining a safe system. The movement of fluids through the dispensing system generates static electricity. Static electricity can cause fumes to ignite, resulting in explosion and fire. To reduce the risk of static sparking, ground all system components per local and national electrical codes. Refer to user manuals for pump and other system components to ground the following:

- **Pump:** Follow manufacturer's recommendations.
- **Air and Fluid hoses:** Use only grounded hoses.
- **Air compressor:** Follow the manufacturer's recommendations.
- **Fluid supply container:** Follow the local code.

To maintain grounding continuity when flushing or relieving pressure, **always** hold a metal part of valve firmly to side of grounded metal pail, then trigger valve.

Pre-Installation Procedure

1. Install the battery. See **Replacing the Battery** on page 31.
2. Follow the **Pressure Relief Procedure**.
3. Close the shut-off valve (B, FIG. 1, page 5).
4. Ground the hose and reel or console. See **Grounding**.

 Leave a minimum of two engaged threads bare when using PTFE tape. The bare threads ensure a ground is maintained.

Installation Procedure

NOTICE
If this is a new installation or if there is contaminated fluid in the lines, flush the lines before you install the metered valve. Contaminated lines could cause the valve to leak.

If this is an existing installation, go to step 7. Steps 1 - 6 are the **Flushing Procedure**.

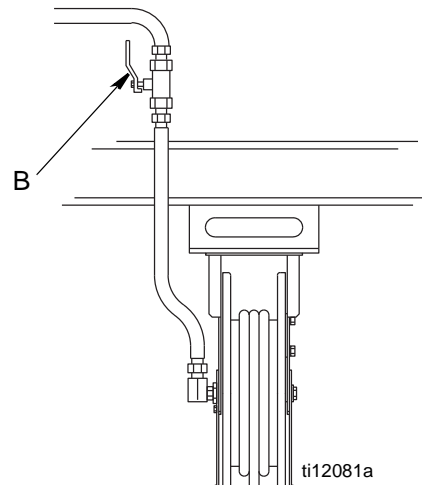

FIG. 3

1. Close the fluid shutoff valve (B, FIG. 3) at each dispense position.
2. Make sure:
 - the main fluid outlet valve at the pump is closed,
 - the air pressure to the pump motor is adjusted,
 - the air valve is open.
3. Slowly open main fluid valve.

4.
 - a. Place the hose end (with no dispense valve connected) into a container for waste oil.
 - b. Secure the hose in the container so it will not come out during flushing.
 - c. If you have multiple dispense positions, first flush the dispense position farthest from the pump, then work your way toward the pump.

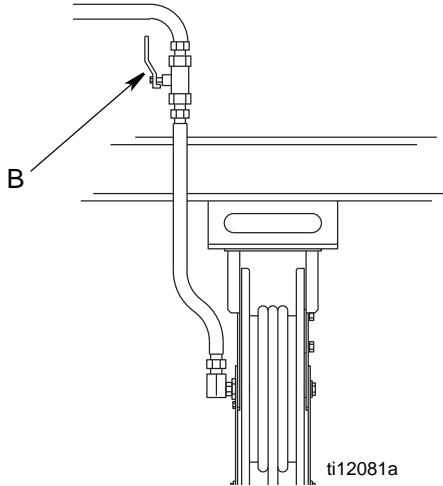

FIG. 4

5. Slowly open the shut-off valve (B, FIG. 4) at the dispense position. Flush out a sufficient amount of oil to ensure that the entire system is clean. Close the valve.
6. Repeat step 5 at all other dispense positions.

Electronic Control Control (1) and Gasket (2) Installation

Kits: 257350 and 257351

NOTICE
It is important to properly seat gasket (2) when installing electronic control (1) to fluid section. An improperly seated gasket could cause the meter to report invalid dispense amounts because the glass reed switches are broken.

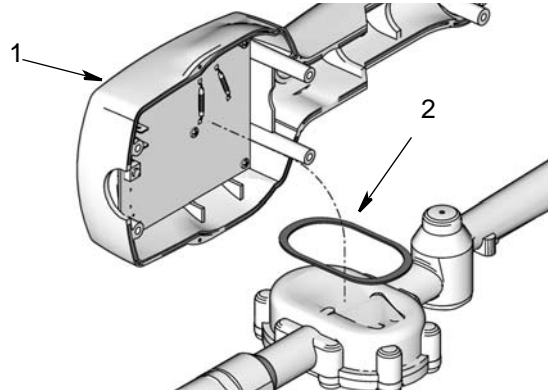

FIG. 5

Connecting Hose to Meter

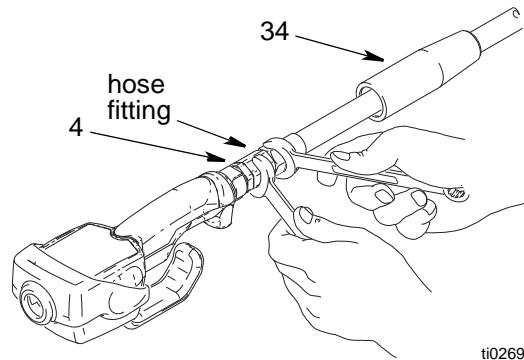



FIG. 6

1. Follow the **Pressure Relief Procedure**, page 6.
2. Slide the swivel cover (34) onto the hose, small end first, before connecting hose fitting to swivel (4) (FIG. 6).
3. Apply thread sealant to the male threads of the hose fitting. Thread the hose fitting into the swivel (4) and tighten firmly (FIG. 6).

 Make sure you let sealant cure to the manufacturer's recommendations before you let fluid into the system.

Installing Extension and Nozzle on Meter

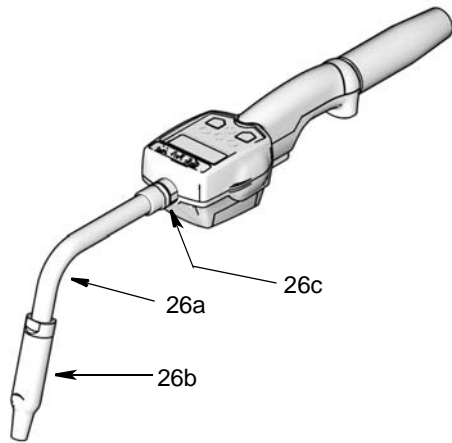



FIG. 7

1. Thread the sealing nut (26c) onto the extension (26a).
2. Thread extension into meter outlet at least three full turns to tighten securely. (FIG. 7). (Over torquing may cause casting meter to split)

NOTICE

- Do not overtighten extension to sealing nut. Over tightening may cause meter casting to split.
- Do not use a twist/lock or manual shut-off nozzle. You must use an automatic nozzle on the meter or the meter could be damaged.

3. Thread new nozzle (26b) onto extension. With an open-end, adjustable wrench. Tighten it firmly.

 **Only** tighten nozzle with the wrench on the flats of the nozzle bushing. **Do not disassemble the bushing from the nozzle.** Disassembly will affect the performance of the nozzle.

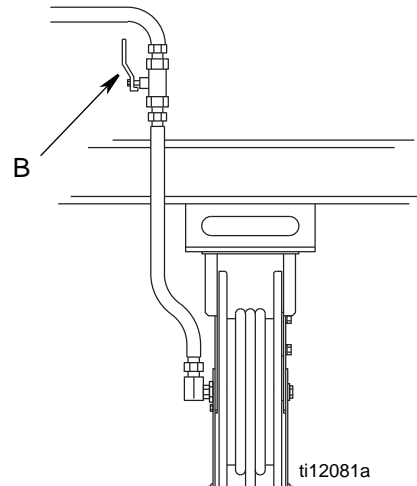

FIG. 8

4. Open all dispense position shut-off valves (B, FIG. 8) and start the pump to pressurize the system. See **Operation**, (LDM5 Meters - page 13; LDP5 Meters - page 22), for proper operation of meter.
 - To ensure dispensing accuracy, purge all air from the fluid lines and dispense valve before you use it.
 - Set the system flow to the desired flow rate, which is typically 1.5 gpm. Do not exceed a 5-gpm flow rate.

LDM5 Meter Setup and Operation Instructions

Setup

Terms

The following terms are shown on the display and/or used often in this instruction manual.

- **R-TOTAL:** Resettable Total
Shows the cumulative amount that has been dispensed. Can be reset to zero.
- **TOTAL:** Non-Resettable Total
Shows the cumulative amount that has been dispensed for the life of the unit. Cannot be reset.
- **Standard Dispense Mode**
Dispense mode in which display counts up from zero or from where it recently stopped.
- **ASLEEP / AWAKE Mode**
Asleep is a battery-saving mode in which the display goes blank after 45 seconds of inactivity. The display comes *Awake* from sleep mode when you press any button on the keypad or squeeze the trigger to dispense fluid.

Keypad Buttons (FIG. 9)

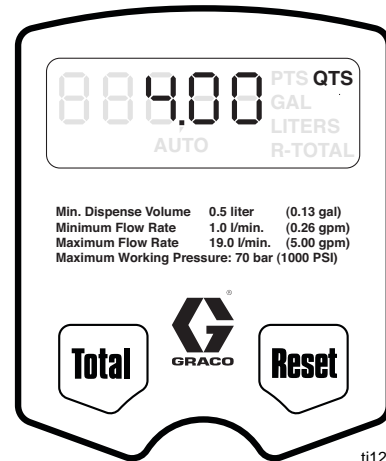



ti12043A

FIG. 9

- **TOTAL***
Displays the resettable total, non-resettable total, and calibration factor.
- **RESET***
Resets the displayed amount to zero or press to enter the Standard Dispense Mode (see Terms).

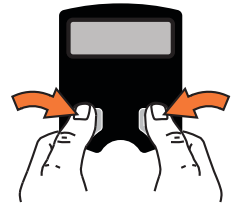
* Press the hold *Reset and Total* buttons simultaneously to display Setup Menu (page 10).



 All buttons are disabled while fluid is being dispensed.

Setup Menus (FIG. 10)

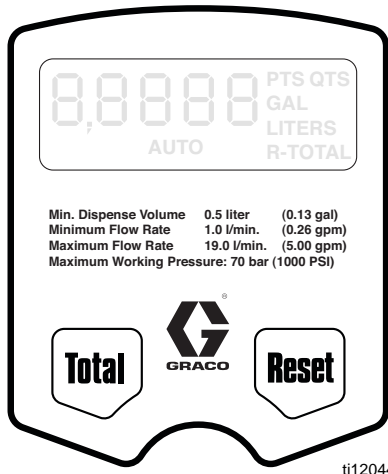



FIG. 10

- c. Press and hold Reset button again to display Calibration Menu. When this menu is displayed CAL blinks on the screen (FIG. 13).

The total that is displayed when you leave each menu is the total that is stored.

 The following sections of this manual provide instructions for using the Setup Menus.

1. If the display is blank (asleep), wake it up by pressing any button on the keypad (FIG. 10).

2. Press and hold the Total and Reset buttons simultaneously for approximately six (6) seconds to enter the Setup Menu (FIG. 10).

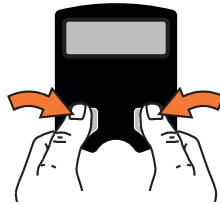

 During the first 4 seconds all segments display. Then for 2 seconds the software version number displays.

3. There are three (3) Setup Menus available, stored in a preset order.
 - a. The first screen displayed is the Resettable Total Menu. When this menu is displayed, R-TOTAL will blink on the screen (FIG. 11).

- b. Press and hold Reset button to display Units of Measure Menu. When this menu is displayed the last set Unit of Measurement blinks on the screen (FIG. 12).

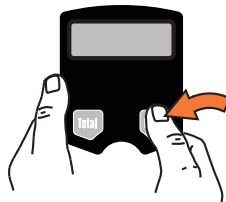

Resettable Total (FIG. 11)

Resets dispensed total on screen to zero or stores displayed dispense total. The resettable total accumulates until the next time it is manually reset.

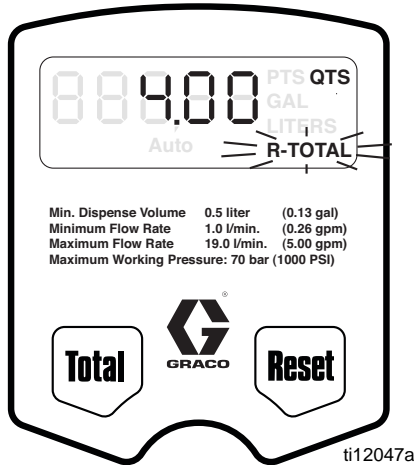
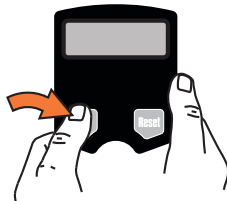

FIG. 11

1. If Resettable Total Menu is not already displayed, complete steps 1 and 2 of **Setup Menu** section.
2. **R-TOTAL** blinks indicating you are on the Resettable Total Menu. The currently stored total and unit of measurement is displayed (FIG. 11).
3. Do **ONE** of the following.

- a. Press and hold the Total button. Resettable total is set to zero (0). **0 GAL/QTS/PTS** or **0 LITERS** is displayed.



- b. Press and hold the Reset button. The zero (0) total is stored. Units of Measurement Menu displays.

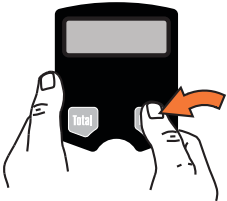

OR

- Press and hold the Reset button. The currently displayed total is stored. The Units of Measurement Menu displays.

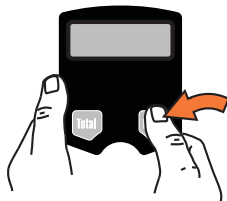

Units of Measurement (FIG. 12)

Sets unit of measurement to quarts, gallons, pints, or liters.

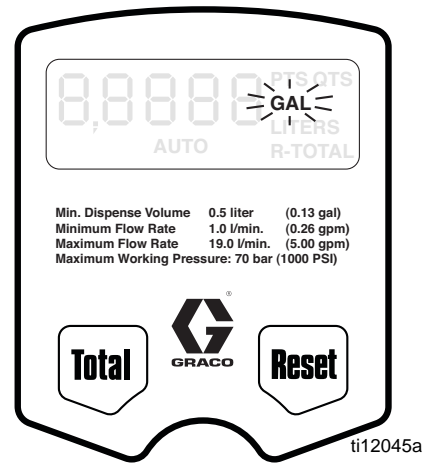
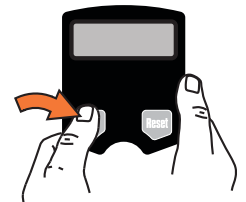

FIG. 12

1. If the Units of Measurement Menu is not already displayed, complete steps 1 - 3 of the **Setup Menu** section, page 10.
2. The currently stored unit of measurement: **GAL**, **QTS**, **PTS** or **LITERS** blinks indicating you are on the Units of Measurement Menu screen.
3. To change the unit of measurement, do **ONE** of the following.

- a. Press and hold Total button to display next unit of measurement in the sequence.



- b. When measurement unit you want to use is displayed, press and hold Reset button. Display advances to Calibration Menu.



OR

- Press and hold Reset button. The currently displayed measurement unit is stored. The Calibration Menu displays.

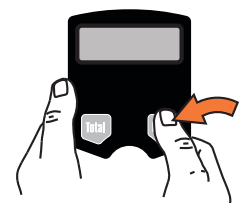

Calibration (FIG. 13)

Recalibrates the meter for dispensing different fluids.

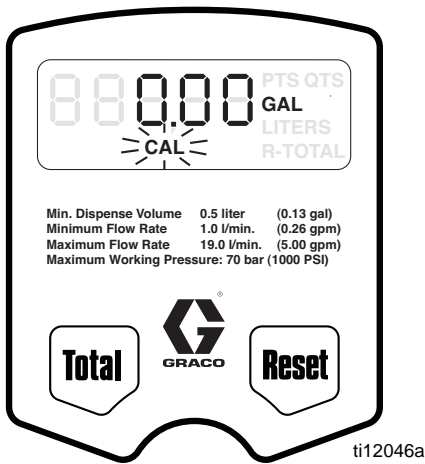

FIG. 13

1. If the Calibration Menu is not already displayed, complete steps 1 - 4 of the **Setup Menus** section, page 10.
2. **CAL** blinks indicating you are on the Calibration Menu screen. Do **ONE** of the following.

Use the current calibration.

- Press and hold Reset button to lock in amount. Display returns to the Standard Mode.

OR

Recalibrate meter as follows:

- a. If the unit of measurement is gallons, pints, or quarts, dispense exactly one quart of fluid into a calibrated 1–quart container.

If the unit of measurement is liters, dispense exactly one liter of fluid into a calibrated 1–liter container.

For proper calibration, you must dispense the exact amount.

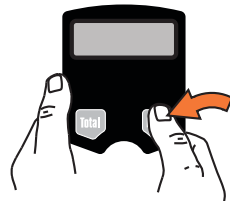

- b. Press and hold Total button until CAL stops blinking and the display shows 1.00.
- c. When CAL starts to blink again, the display should show 1.00. The new calibration is complete.

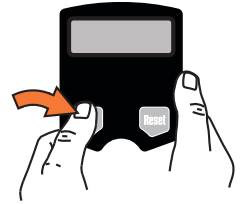

OR

To return to the default calibration:

Press and hold the Total button until CAL stops blinking and the display shows 0.98 (if the unit of measurement is gallons, pints or quarts) or 0.99 (if the unit of measurement is liters).

 If an error was made during meter recalibration, repeat Steps a - c of the recalibration process to recalibrate the meter again.

3. Press and hold the Reset button. The unit returns to Standard Dispense Mode.

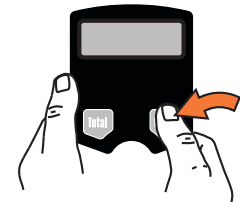

Operation

Dispensing Fluid in Standard Mode

 All buttons are disabled while fluid is being dispensed.



FIG. 14

1. If the display was blank (in sleep mode), press and hold the Total or Reset button. The amount of the last dispense appears on the display (FIG. 14).

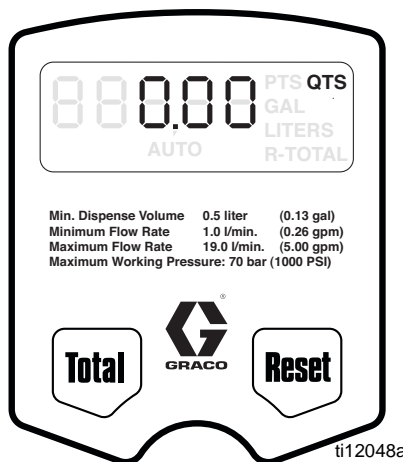
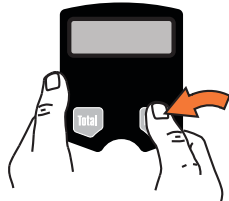
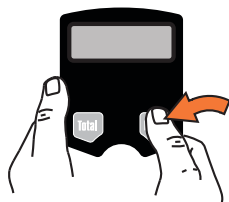

FIG. 15

2. Press and hold Reset button.

0.00 is shown on the display as shown in FIG. 15.



3. Squeeze the trigger.

Fluid begins to flow, and the amount shown on the display counts up from zero.

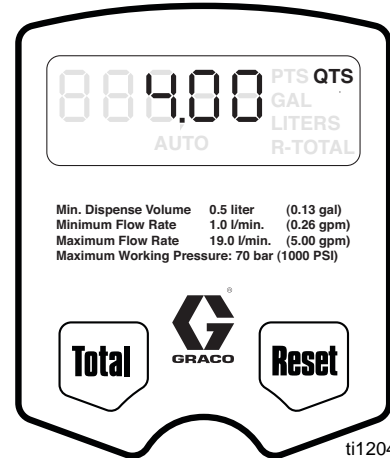



FIG. 16

4. Release the trigger when you have dispensed the desired amount of fluid.

Fluid flow stops, and the amount you have dispensed is shown on the display (FIG. 16).

 When you release the trigger, the nozzle should prevent fluid from running out of the extension. If fluid does run out, see **Replacing the Nozzle** on page 31.

Viewing Totals

This is the procedure for viewing the non-resettable and resettable totals in gallons or liters. To change the resettable total, see Resettable Total, page 11.

1. If display is blank (in sleep mode), press and hold either the Total or Rest button.

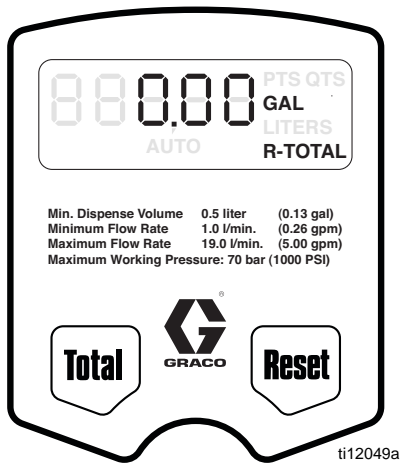
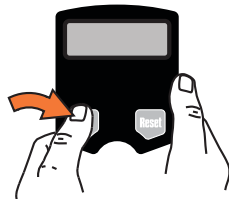

FIG. 17

2. Press and hold Total button. The resettable total amount is displayed (FIG. 17).



If the unit of measurement is gallons, quarts, or pints, the resettable total is displayed in gallons, (FIG. 17). If the unit of measurement is liters, the resettable total is displayed in liters.

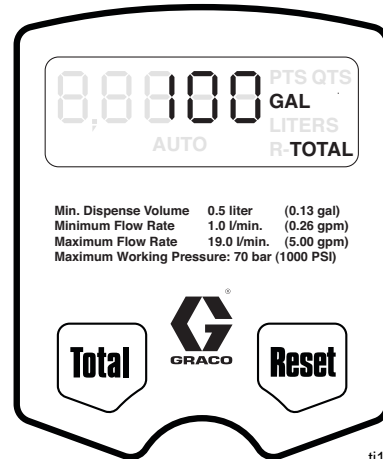

FIG. 18

3. Press and hold the Total button again to display the non-resettable total (FIG. 18).



Each time you press and hold the Total button the display toggles between the non-resettable and resettable totals.

4. Press and hold the Reset button. The unit returns to Standard Dispense Mode.

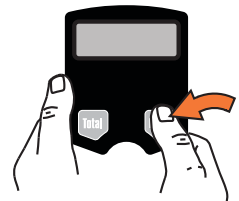

Error Code

If an error code is shown on the display, as shown in FIG. 19, you can press the Reset button to clear the error code and view the dispensed amount. Even in an error condition, the unit keeps track of the amount dispensed.

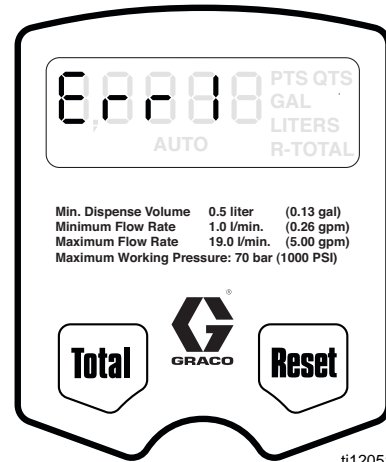
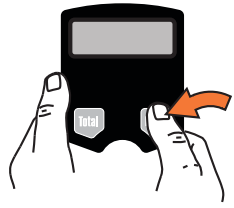

FIG. 19

Error Code	Cause	Solution
Err 1	Flow rate is higher than 5 gpm. Air was pumped through the line.	Adjust the flow rate so it is not higher than 5 gpm. Purge air from the line.

LDP5 Meter Setup and Operation Instructions

Setup

Locking and Unlocking the Trigger

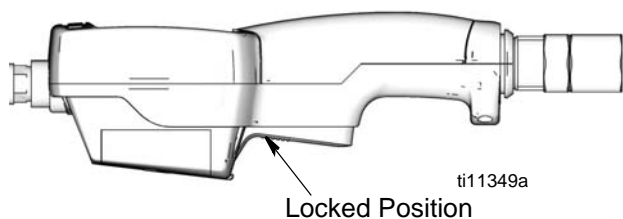

FIG. 20

To lock the trigger (FIG. 20), press on the part of the trigger that has the textured grip until you feel it click into the locked position.

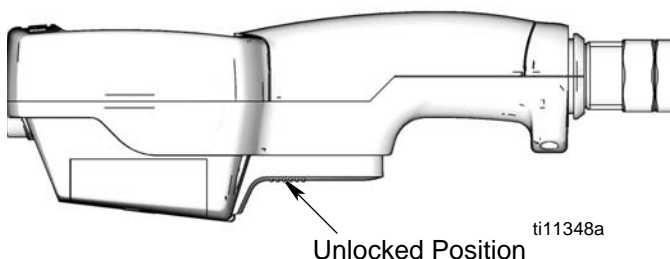

FIG. 21

To unlock the trigger (FIG. 21), press on the smooth part of the trigger until you feel it click out of the locked position. When you release the trigger, fluid flow stops.

In Auto mode, the unit stops dispensing when the entered amount has been dispensed.

In Manual mode, the trigger does not automatically unlock; you must unlock it manually.

Terms

The following terms are shown on the display and/or used often in this instruction manual.

- **R-TOTAL:** Resettable Total
Shows the cumulative amount that has been dispensed in all modes. Can be reset to zero.
- **TOTAL:** Non-resettable Total
Shows the cumulative amount that has been dispensed in all modes for the life of the unit. Cannot be reset.
- **Manual Mode**
Dispense mode in which display counts up from zero to show the dispensed amount. In this mode, you may lock the trigger, but you must manually unlock it when the desired amount is dispensed. Memory setting also unlocks the trigger.
- **Auto Mode**
Dispense mode in which a preset, user-entered amount is dispensed. When the preset amount is dispensed, the trigger unlocks to stop the unit from dispensing and the amount dispensed is displayed. At this point, you may dispense more by pulling back the trigger, and the display resumes counting up.
- **Asleep / Awake Mode**
Asleep is a battery-saving mode in which the display goes blank after 45 seconds of inactivity. The display comes *Awake* from sleep mode when you press any button or squeeze the trigger to dispense fluid.

Keypad Buttons (FIG. 22)

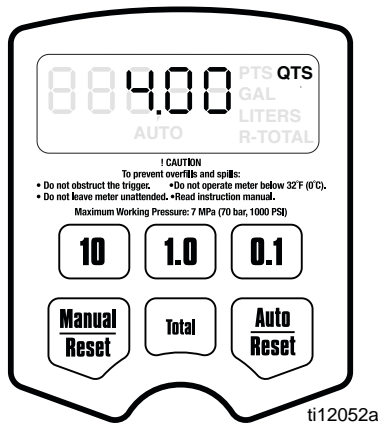
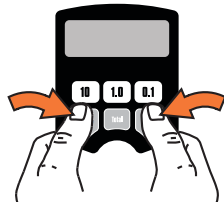



FIG. 22

- **Manual / Reset***
Used to select Manual Mode dispensing (see Terms). The first push selects the mode, and the second push resets the display to zero.
- **Auto / Reset***
Used to select Auto Mode dispensing (see Terms). The first push selects the mode, and the second push resets the display to zero.

* Press **Manual / Reset** and **Auto / Reset** buttons simultaneously to display the Setup Menu (page 17).



- **Total**
Used in any mode to see the resettable total and the non-resettable total.
- **10, 1.0, and 0.1**
Used in Auto Mode and during setup to enter dispense amounts.

 All buttons are disabled while fluid is being dispensed.

Setup Menu (FIG. 23)

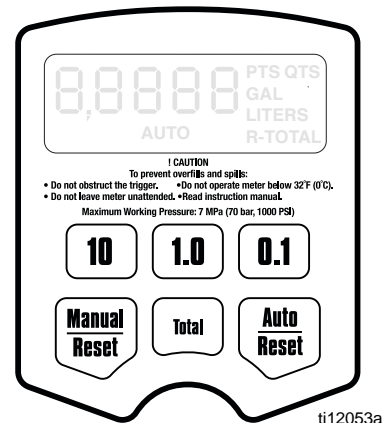
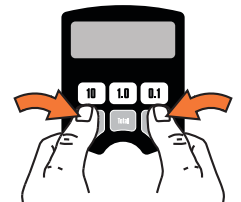



FIG. 23

1. If the display is blank (asleep), wake it up by pressing any button on the keypad.



2. Press and hold the **Manual/Reset** and **Auto/Reset** buttons simultaneously for approximately 6 seconds to enter the Setup Menu .



 During the first 4 seconds all segments display. Then for 2 seconds the software version number displays.

3. There are five (5) Setup Menu screens available, stored in a preset order.
 - a. The first screen displayed is the Resettable Total Menu (FIG. 24, page 18). When the menu is displayed, R-TOTAL (G) will blink in the lower right corner on the screen.

- b. Press and hold the **Auto / Reset** button to display the Units of Measure Menu (FIG. 25, page 19). When this menu is displayed the last set Unit of Measurement blinks in the lower right corner on the screen.



- c. Press and hold the *Auto / Reset* button again to display the Calibration Menu (FIG. 26, page 19). When this menu is displayed CAL will blink on the screen.
- d. Press the *Auto / Reset* button again to display the Auto Preset Amount Menu (FIG. 27, page 20). When this menu is displayed, **AUTO** blinks and the currently stored auto preset amount is displayed.
- e. Press the *Auto / Reset* button again to display the Shut-off Default Amount Menu (FIG. 28, page 21). When the menu is displayed the **clock icon** blinks and the stored shut-off default amount is displayed.

The value that is displayed when you leave each menu is the value that is stored.

Resettable Total (FIG. 24)

Resets the dispense total to zero or stores the displayed dispense total. The resettable total accumulates until the next time it is manually reset.

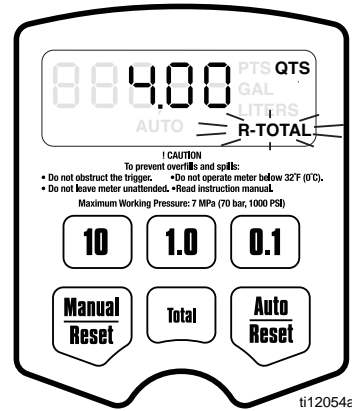
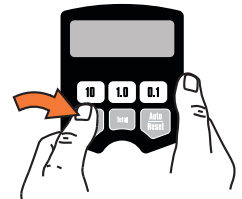

FIG. 24

1. If the Resettable Total screen is not already displayed, complete steps 1 - 2 of the **Setup Menu** section.
2. **R-TOTAL blinks** indicating you are on the Resettable Total Menu screen. The currently stored total and unit of measurement are displayed.
3. Do **ONE** of the following.

- a. Press and hold the *Manual / Reset* button to reset the total to zero (0).



- b. Press and hold the *Auto / Reset* button to store the zero (0) measurement unit. The Units of Measurement Menu displays.

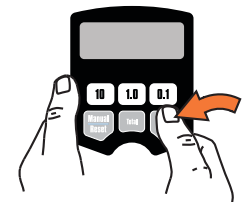

OR

- Press and hold the *Auto / Reset* button to store the currently displayed total. The Units of Measurement Menu displays.

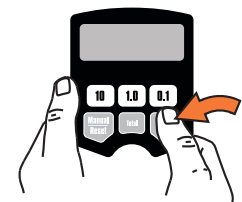

Units of Measurement (Fig. 25)

Sets the units of measurement to gallons, quarts, pints, or liters.

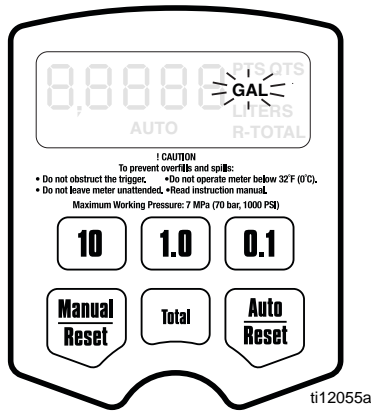

FIG. 25

Calibration (Fig. 26)

Recalibrates the meter for dispensing different fluids.

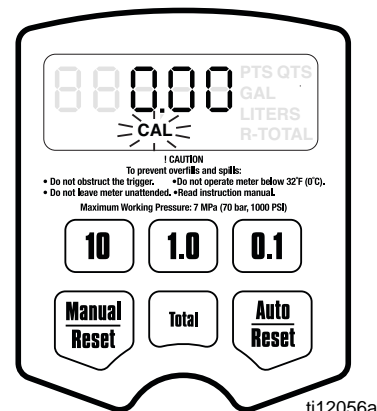

FIG. 26

1. If the Units of Measurement Menu is not already displayed, do steps 1- 3 in **Setup Menus** section, page 17.
2. **GAL, QTS, PTS or LITERS** blinks indicating you are on the Units of Measurement Menu screen.
3. Do **ONE** of the following.

- a. Press and hold *Manual / Reset* button to display next unit of measurement in sequence. Each time you press and hold the button, the next unit of measurement displays.



- b. When measurement unit you want to use is displayed, press and hold *Auto / Reset* button to lock in new measurement unit. Calibration Menu displays.

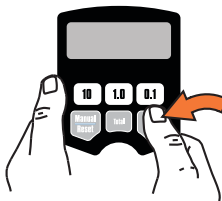

OR

- Press and hold the *Auto / Reset* button. The currently displayed measurement unit is stored. Calibration Menu displays.

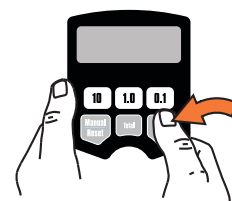

1. If the Calibration Screen is not already displayed, complete steps 1 - 4 of the **Setup Menus** section, page 17.
2. **CAL** blinks indicating you are on the Calibration Menu screen.
3. Do **ONE** of the following.

Use the current calibration.

- Press and hold the *Auto / Reset* button to lock in the displayed amount. The display advances to the Auto Preset Amount Menu.

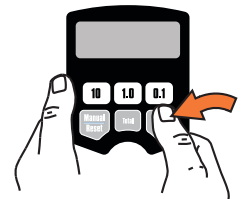

OR

Recalibrate the meter as follows.

- a. If the unit of measurement is gallons, pints, or quarts, dispense exactly one quart of fluid into a calibrated 1–quart container.

If the unit of measurement is liters, dispense exactly one liter of fluid into a calibrated 1–liter container.

For proper calibration, you must dispense the exact amount.

b. Press and hold the *Manual / Reset* button until CAL stops blinking.

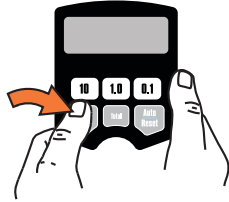

c. When CAL starts to blink again, the display should show 1.00, which indicates the new calibration is complete.

If an error was made during meter recalibration, repeat Steps a - c of the recalibration process to recalibrate the meter again.

d. Press and hold the *Auto / Reset* button to advance to the Auto Preset Amount Menu.



Auto Preset Amount (Fig. 27)

Specifies an amount displayed when you enter the Auto Dispense Mode. Typically, you would enter the amount you most frequently dispense.

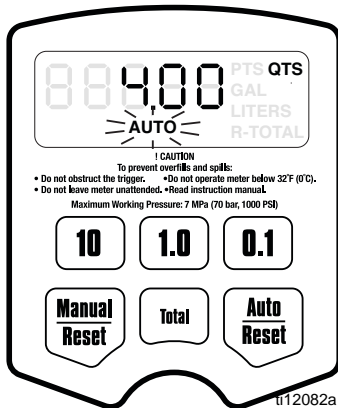
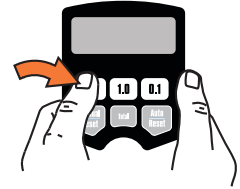

FIG. 27

1. If the Auto Preset Amount screen is not already displayed, complete steps 1 - 5 of the **Setup Menus** section, page 17.
2. **AUTO** blinks indicating you are in the Auto Preset Amount Menu. The currently stored auto preset amount is displayed. (This is the amount that is displayed when the *Auto / Reset* button is pressed during normal operation.)

3. Do **ONE** of the following.

a. To enter a new auto preset amount press and hold the 10 button to change the 10's digit,



the 1.0 button to change the 1's digit,



and the 0.1 button to change the first decimal digit. **You cannot enter zero.**



To reset the display to 0.00, press and hold the *Manual / Reset* button.

b. Press and hold the *Auto / Reset* button to lock in the amount. The Shut-Off Default Amount Menu displays.

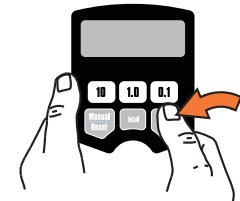

OR

- Press and hold the *Auto / Reset* button to lock in the currently displayed auto preset amount. The display advances to the Shut-Off Default Amount Menu.

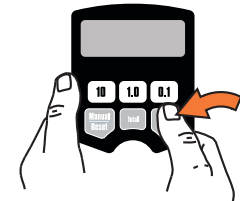

Shut-Off Default Amount (Fig. 28)

Prevents accidental overfills when dispensing with the trigger locked in Manual mode. The shut-off default amount is factory preset at 5 quarts.

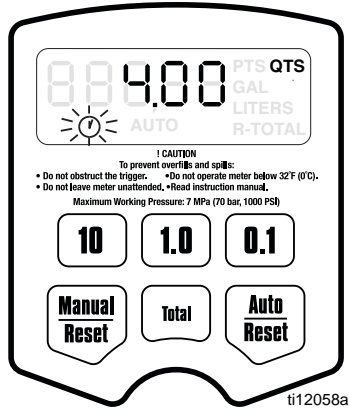
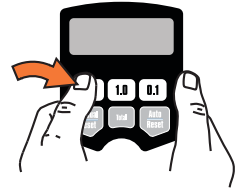

FIG. 28

1. If the Shut-Off Default Amount Menu is not already displayed, complete steps 1 - 6 of the **Setup Menus** section, page 17.
2. The **clock icon** blinks indicating you are in the Shut-off Default Amount Menu. The stored shut-off default amount is displayed.

3. Do **ONE** of the following.

- a. To enter a new shut-off default amount, press and hold the 10 button to change the 10's digit,



the 1.0 button to change the 1's digit,



and the 0.1 button to change the first decimal digit. **You cannot enter zero.**

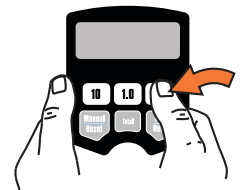

 To reset the display to 0.00, press and hold the *Manual/Reset* button.

- b. Press and hold the Auto / Reset button to lock in the new shut-off default amount and return to the unit to the Manual Dispense Mode.

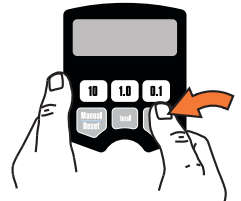

OR

- Press and hold the Auto/Reset button to return to the unit to the Manual Dispense Mode.

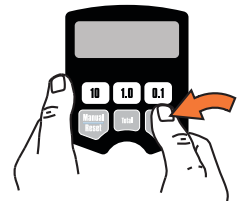

Operation

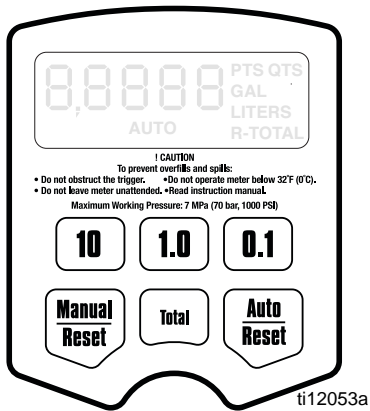

FIG. 29

Fluid flows, and the amount displayed counts up from zero or the previously dispensed amount.

- Release/unlock the trigger when you have dispensed the desired amount of fluid.

Fluid flow stops. The amount you have dispensed is displayed.

You may press and hold the Manual/Reset button again to reset the displayed amount to zero.

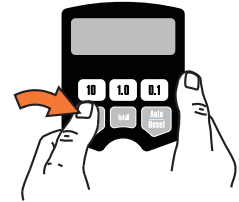

Dispensing Fluid in Manual Mode (FIG. 29)

- Press and hold the Manual/Reset button.

- If the display was blank (asleep), it wakes up and displays the amount that was displayed before it fell asleep.



- If the display was awake, and the meter is in the Manual Dispense Mode, the display clears to **0.00**.
- If the display was awake, and the unit is in the Viewing Totals mode or the Auto Dispense Mode, the meter switches to the Manual Dispense Mode.

- When the display is awake, you can dispense from zero or from the displayed amount by doing **one** of the following.

- Press and hold the Manual/Reset button again to clear the display to **0.00** if it is not already at **0.00**. Then go to step 3.

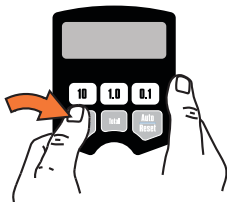

OR

- Go straight to step 3 to dispense from the displayed amount.

- Squeeze the trigger. You may lock it. See **Locking and Unlocking the Trigger**, page 16.

When the trigger is released, the automatic nozzle prevents the fluid in the extension from running out.

Dispensing Fluid in Auto Mode (FIG. 30)

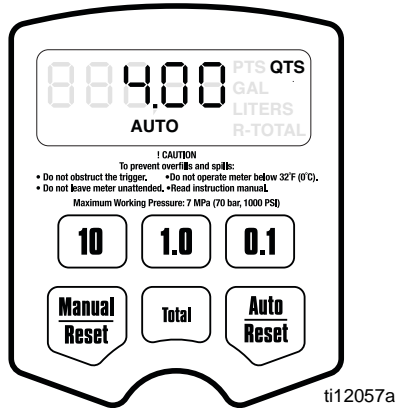

FIG. 30

NOTICE

Before you begin a preset dispense cycle, make sure **AUTO** is displayed. If you do not see **AUTO** on the display, you are not in the Auto dispense mode, and fluid flow will not stop when the auto preset amount is dispensed.

1. Press and hold the *Auto/Reset* button.

*The display wakes up if it was asleep, and **AUTO** and the stored preset dispense amount are displayed. The factory default is **5.00**.*



 To change the **stored** preset dispense amount, see **Auto Preset Amount** on page 20.

2. You can dispense or change the displayed preset amount by doing **one** of the following.
 - Go straight to step 3 to dispense the displayed preset amount.

OR

- To change the displayed preset amount:

- a. Press and hold the *Auto/Reset* button to set the display to zero.

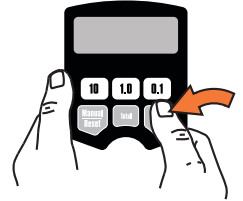

- b. Press the **10** button to change the 10s digit,



press the **1.0** button to change the 1s digit,



and the **0.1** button to change the first decimal digit. **You cannot enter zero.**

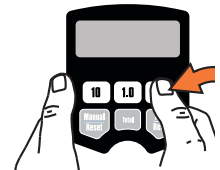

 To reset the display to 0.00, press and hold the *Manual/Reset* button.

3. Lock the trigger. See **Locking and Unlocking the Trigger** on page 16.

Fluid flows, and the displayed dispensed amount counts up from zero. When the preset amount is dispensed, the trigger unlocks, fluid flow stops, the dispensed amount is displayed, and the meter switches to the Manual Dispense Mode.

*If you want to stop fluid flow **before** the preset amount is dispensed, manually unlock the trigger. To continue the dispense, lock the trigger, and the dispensed amount resumes counting toward the preset amount.*

*If you want to continue dispensing **after** the trigger unlocks at the preset dispense amount, squeeze the trigger, and the dispensed amount resumes counting until you release the trigger.*

 When the trigger unlocks, the automatic nozzle prevents the fluid in the extension from running out.

Viewing Totals

This is the procedure for viewing the non–resettable and resettable totals. To change the resettable total, see **Resettable Total** on page 18.

1. If the display is blank (asleep), press and hold the *Manual/Reset* or *Auto/Reset* button to wake it up.



Resettable Totals

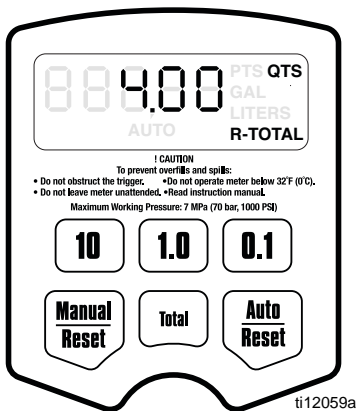
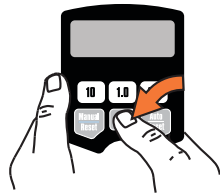

FIG. 31

2. Press and hold the Total button to view the resettable total amount (FIG. 31).



Non-Resettable Totals

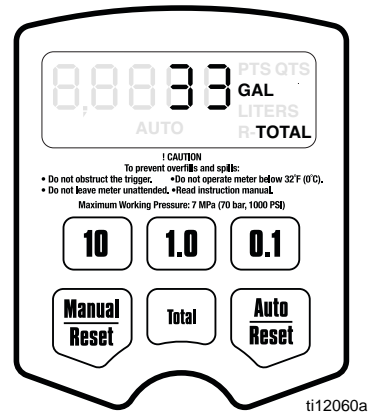
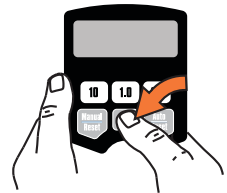

FIG. 32

3. Press and hold the Total button again to view the non-resettable, grand total amount.



If the unit of measurement is gallons, quarts, or pints, the resettable total is displayed in gallons, (FIG. 32). If the unit of measurement is liters, the resettable total is displayed in liters.

Pressing and holding the Total button repeatedly toggles between the non–resettable and resettable total.

4. Press and hold the *Manual/Reset* or *Auto/Reset* button to return to the Manual or Auto Dispensing Mode.

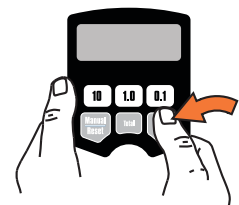

Error Codes

Error codes are listed below. Even in an error condition, the unit keeps track of the amount dispensed. With any error code displayed, as shown at right, you can:

- Press the Manual/Reset button. Error code is cleared, unit switches into Manual mode, and dispensed amount is displayed.
- Press the Auto/Reset button. Error code is cleared, unit switches into Auto mode, and the preset amount is displayed.

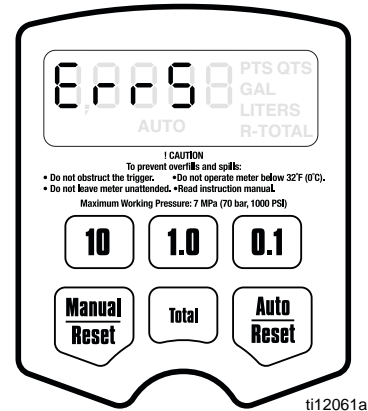
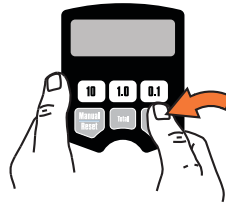



FIG. 33

Error Code	Cause	Solution
Err 1	Flow rate is higher than 5 gpm. Air was pumped through the line.	Adjust the flow rate so it is not higher than 5 gpm. Purge air from the line.
Err 4	Flow has continued after it should have shut off.	Check if unit is resting on the trigger if an obstruction is pressing the trigger. The unit checks for flow every second and repeats the error code until the trigger is released and the error code cleared.
Err 5	The unit has dispensed the shut-off default amount and has stopped fluid flow.	Press the Manual/Reset button, and dispense again. To change the shut-off default amount, see Shut-off Default Amount , page 21.
Err 6	A preset dispense amount of zero was entered for the dispense or is stored as the default, and a Preset dispense was attempted.	Enter an amount that is not zero. See Dispensing Fluid in Auto Mode , page 23.

Troubleshooting

						
<p>Relieve Pressure Relief Procedure, page 5, before you check or repair the meter. Be sure all other valves and controls and the pump are operating properly.</p>						

Problem	Cause	Solution
Battery icon is displayed.	Battery is low.	Replace the battery. See Replacing the Battery , page 31.
Battery icon is blinking, and bAtt (BATT) is blinking.	Battery is dead or is not suited for this application (poor quality).	Replace the battery. See Replacing the Battery page 31.
Display does not activate or is showing unintelligible character.	Battery is defective or dead.	Replace the battery. See Replacing the Battery page 31.
	Electronic control is malfunctioning.	Replace the electronic control (clamshell).
	A dispense mode has not been selected.	Select a dispense mode by pressing the Manual/Reset button or the Auto/Reset button.
Slow or no fluid flow	Filter is clogged.	<ol style="list-style-type: none"> Relieve the pressure. Clean or replace the filter. See Replacing the Filter, page 31. If the problem remains, contact your Graco distributor for repair or replacement.
	Pump pressure is low.	Turn up pump pressure.
	Shut-off valve is not fully open.	Fully open shut-off valve.
	Foreign material is jammed in the meter housing.	Contact your Graco distributor for repair or replacement.
Displayed dispensed amount is not accurate.	Unit needs to be calibrated for the fluid that is being dispensed.	Calibrate the meter for the fluid that is being dispensed. See Calibration on page 19.
Oil leaks from where fluid outlet tube connects to housing.	Outlet tube or sealing nut or street elbow is loose or damaged.	Check outlet tube, sealing nut, and street elbow for looseness or damage and tighten or replace.
	Sealing nut is oriented the wrong way.	Make sure the PTFE seal on the sealing nut is facing the surface against which it is tightened.

Problem	Cause	Solution
Meter leaks from Cover/Control	Poor swivel (3)/hose connection.	Apply PTFE tape (leave minimum 2 engaged threads uncovered for electrical continuity) or sealant to threads of hose and tighten the connection. See step 9 in Installation Procedure .
	Poor swivel (3)/meter housing connection.	Torque the fitting to 20-25 ft-lb (27 to 34 N•m).
	Damaged valve stem assembly.	Replace or clean valve stem and O-rings. Order Valve Repair Kit 240453.
	Poor seal at meter housing plate. NOTE: Place a straight edge along meter housing plate. If flat, plate and seal are ok. If plate is not flat, meter is damaged.	Contact your Graco distributor for repairs or replacement.
Meter leaks from Automatic nozzle NOTE: It is important to distinguish between the two causes of this problem. A new nozzle will not correct a fluid leak caused by a faulty valve.	Automatic nozzle has a damaged seal.	Replace the nozzle. See Replacing the Nozzle , page 31.
	Valve has damaged or obstructed seals.	Replace or clean valve stem and o-rings. Order Valve Repair Kit 240453.
LDP5 ONLY: Unit does not stop dispensing when assumed auto amount is dispensed.	Auto amount was not entered correctly.	Enter a preset dispense amount in the Auto dispense mode. AUTO must be displayed below the amount.

Parts

FN	Part No.	Description	Qty	FN	Part No.	Description	Qty
1	257350	CONTROL, electronic, LDM5, includes 15M845, (models 255751, 256215, 258693, 24F881, 24F882, 24F885, 24F887, 24F888, 24F891)	1	239951	KIT, nozzle, flexible, extension for oil and anti-freeze, includes 26a - 26c (models 255751, 255277, 258693, 258694, 2F881, 24F883, 24F885, 24F886, 24F887, 24F889, 24F891, 24F892)		1
	257351	CONTROL, electronic, LDP5, includes 15M845 (models 255277, 256216, 258694, 24F883, 24F884, 24F886, 24F889, 24F890, 24F892, 24X465)	1	26a	EXTENSION		1
2	15T124	GASKET, bumper	1	26b	NOZZLE, dispenser		1
3*		HOUSING, meter		26c	113419 NUT, sealing		1
4	240416	SWIVEL, straight, 1/2-14 NPT	1	29	196829 LABEL, information (not shown)		1
	24G805	SWIVEL, straight, 1/2-14 BSPT	1	32	113716 BATTERY, 9-volt		1
	24G806	SWIVEL, straight, 1/2-14 BSPP	1	34	191294 COVER, swivel, black		1
8	255884	KIT, filter, 80 mesh, includes 8a and 8b	1		(models 256215, 256216, 258693, 258694, 24F882, 24F884, 24F885, 24F886)		
8a		STRAINER, filter	10	125962	BOOT, black, BSPP (models 24F888, 24F890, 24F891, 24F892)		1
8b		PACKING, o-ring	10	191287	red (optional)		
11	240453	KIT, repair, valve, includes 11a - 11f and 1 each, 8a and 8b.	1	191288	blue (optional)		
11a		SPRING, compression	1	191289	green (optional)		
11b		PACKING, o-ring, valve	3	191295	yellow (optional)		
11c		STEM, valve	1	35	247759 GUARD, impact, black (models 256215, 256216, 258693, 258694, 24F882, 24F884, 24F885, 24F886, 24F888, 24F890, 24F891, 24F892)		1
11d		PACKING, o-ring	1	247760	yellow (optional)		
11e		PACKING, o-ring	1	243835	red (optional)		
11f		SEAT, valve	1	243836	blue (optional)		
17	113412	SCREW, mach, torx pan head	6	243837	green (optional)		
18	191046	TRIGGER	1	38	15M845 COVER, battery		1

*Not a purchase part. Shown for reference only.

EM5/PM5 Upgrade Kits†

Part No.	Description
257350	EM5 to LDM5
257351	PM5 to LDP5

† Includes FN 1 (257350 or 257351) and FN 2 (15T124) above

Nozzle Extension Accessory Kits (FN 26)

Part No.	Description	Lubricant Type
238371	Nozzle (b) only	Gear Lube
239829	Nozzle (b) only	Oil and Anti-freeze
238887	Rigid, includes extension (a), nozzle (b) and fitting (c)	Gear Lube
239951	Flexible, includes extension (a), nozzle (b) and fitting (c)	Oil and Anti-freeze

Thermal Relief Kits (page 5)

Part No.	Description	PSI (bar) Rating
112353	Diaphragm pump for fuel dispense, valve only	50 psi (3.4 bar)
235998	Mini Fire-Ball™ 225, 3:1	600 psi (41 bar)
237601	Fire-Ball 425, 3:1	600 psi (41 bar)
237893	Fire-Ball 300, 5:1 and Fire-Ball 425, 6:1	900 psi (62 bar)
248296	Fire-Ball 300, 5:1 and Fire-Ball 425, 6:1 (same as 237893 minus bung adapter and swivel. Includes 6-foot hose)	900 psi (62 bar)
238899	Diaphragm pump	150 psi (10.4 bar)
240429	Fire-Ball 425, 10:1	1600 psi (110 bar)
248324	Fire-Ball 425, 10:1 (same as 240429 minus bung adapter and swivel. Includes 6-foot hose)	1600 psi (110 bar)

Models 256215, 256216, 24F882,
24F884, 24F888, 24F890
26: Rigid Extension
Kit: 239949

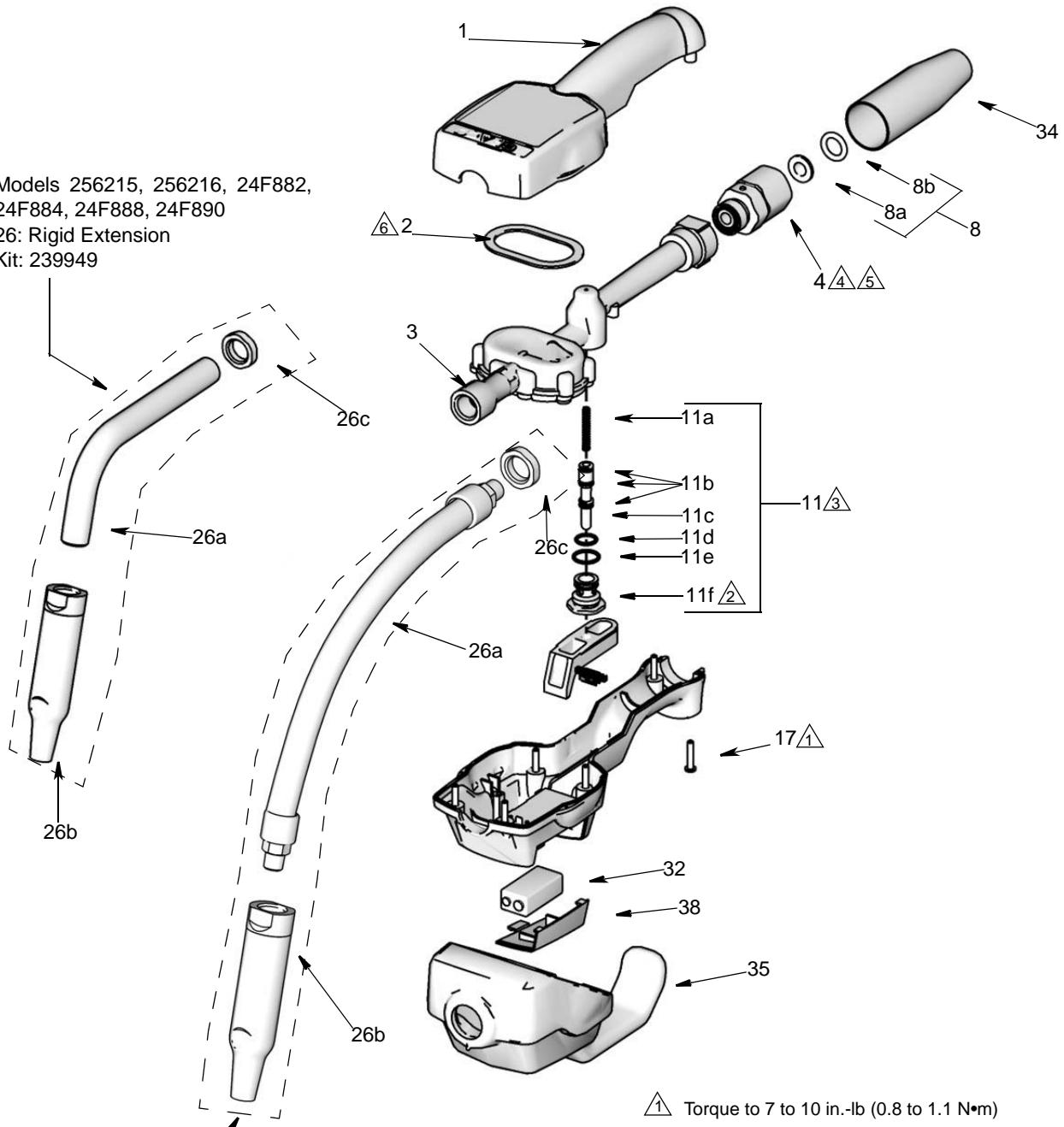

26: Flexible Extension
Kit: 239951
Models 255751, 255277, 258693, 258694,
24F885, 24F886, 24F891, 24F892,
255751, 255277, 24F881, 24F883,
24F887, 24F889



- ⚠️ Torque to 7 to 10 in.-lb (0.8 to 1.1 N•m)
- ⚠️ Torque to 140 to 150 in.-lb (16 to 17 N•m)
- ⚠️ Apply lubricant when reassembling
- ⚠️ Torque to 20 to 25 ft-lb (27 to 34 N•m)
- ⚠️ Apply thread sealant when assembling
- ⚠️ Housing surface (3) must be clean to ensure proper adhesive bonding of gasket (2)

Service

Replacing the Battery

NOTICE

Do not change the battery while anything is shown on the display. You must wait until the unit falls asleep and the display is blank before you remove the battery. If you remove the battery while something is shown on the display, that information will be lost from memory.

						
---	---	--	--	--	--	--

Only replace the battery in a non-hazardous location, away from flammable fluids or fumes. Battery required to meet safety approvals:

- Duracell® alkaline MN1604, PC1604 or
- Eveready® alkaline EN22, 522

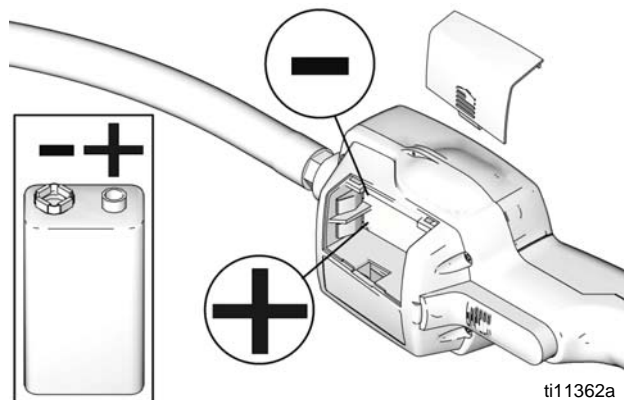

FIG. 34

To change the battery, remove the battery cover, and replace the old battery with a new battery (FIG. 34).

Replacing the Nozzle

If the nozzle begins to leak, replace it. **Refer to Installing Extension and Nozzle on Meter** instructions, on page 8

Security Seal

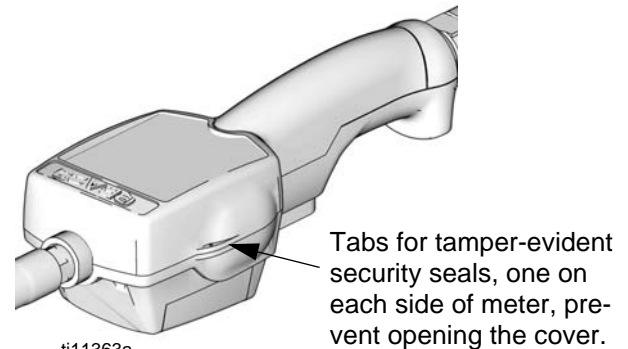



FIG. 35

The security seal is used to prevent access to the inside of the meter and tampering with the meter settings. See FIG. 35.

Replacing the Filter

1. Follow the **Pressure Relief Procedure**, page 6.
2. Unscrew the hose from the swivel (4).
3. Remove the o-ring (8b) and the filter (8a) from inside of the swivel (4) with an o-ring pick.
4. Push the new filter (8a) into the swivel (4), and make sure it is properly seated.

 Orient the new filter (8a) so the concave side of the screen faces downstream, as shown below

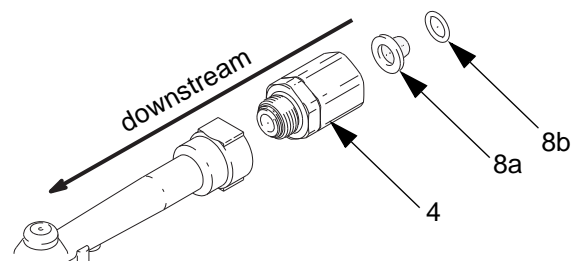

FIG. 36

5. Replace the o-ring (8b).
6. Thread the hose back into the swivel (4).

Technical Data

Flow range*	0.1 to 5 gpm (0.4 to 19 lpm)
Maximum Working Pressure	1000 psi (69 bar)
Weight	3 lbs (1.36 kg)
Dimensions without extension/nozzle Length Width Height	11 inches (28 cm) 3.25 inches (8.3 cm) 3.25 inches (8.3 cm)
Inlet	1/2" npt, 1/2" BSPP, 1/2" BSPT
Outlet	3/8" npt
Operating temperature range	32°F to 120°F (0°C to 49°C)
Storage temperature range	-30°F to 120°F (-34°C to 49°C)
Battery**	9 volt alkaline
Wetted parts	stainless steel, nitrile rubber, zinc, CS, LCP
Fluid compatibility	lubricating oils, antifreeze mixtures
Pressure loss Accuracy†	90 psi (1.2 bar) @ 5 GPM +/- 0.5 percent
Units of measurement Maximum totalizer amount Maximum recorded dispensed volume Maximum preset volume (LDP5 Meter only)	pints, quarts, gallons, liters (factory set in quarts) 99,999 units 999.99 units 999.9 units

* Tested in No. 10W motor oil. Flow rates vary with fluid pressure, temperature and viscosity.

** Battery required to meet safety approvals: Duracell® MN1604 or Eveready® EN22, 522

† At 2.5 gpm (9.5 lpm), at 70°F (21°C), with 10W motor oil and 1 gallon (3.8 l) dispensed. May require calibration; out-of-box accuracy is +/-1.25 percent.

Duracell® is a registered trademark of Duracell Inc.

Eveready® is a registered trademark of the Eveready Battery Co., Inc.

Graco 5-Year Meter and Valve Warranty

Graco warrants all equipment referenced in this document which is manufactured by Graco and bearing its name to be free from defects in material and workmanship on the date of sale to the original purchaser for use. With the exception of any special, extended, or limited warranty published by Graco, Graco will, for a period from the date of sale as defined in the table below, repair or replace equipment covered by this warranty and determined by Graco to be defective. This warranty applies only when the equipment is installed, operated and maintained in accordance with Graco's written recommendations.

Graco 5-Year Meter and Valve Extended Warranty	
Components	Warranty Period
Structural Components	5 years
Electronics	2 years
Wear Parts - including but not limited to o-rings, seals and valves	1 year

This warranty does not cover, and Graco shall not be liable for general wear and tear, or any malfunction, damage or wear caused by faulty installation, misapplication, abrasion, corrosion, inadequate or improper maintenance, negligence, accident, tampering, or substitution of non-Graco component parts. Nor shall Graco be liable for malfunction, damage or wear caused by the incompatibility of Graco equipment with structures, accessories, equipment or materials not supplied by Graco, or the improper design, manufacture, installation, operation or maintenance of structures, accessories, equipment or materials not supplied by Graco.

This warranty is conditioned upon the prepaid return of the equipment claimed to be defective to an authorized Graco distributor for verification of the claimed defect. If the claimed defect is verified, Graco will repair or replace free of charge any defective parts. The equipment will be returned to the original purchaser transportation prepaid. If inspection of the equipment does not disclose any defect in material or workmanship, repairs will be made at a reasonable charge, which charges may include the costs of parts, labor, and transportation.

THIS WARRANTY IS EXCLUSIVE, AND IS IN LIEU OF ANY OTHER WARRANTIES, EXPRESS OR IMPLIED, INCLUDING BUT NOT LIMITED TO WARRANTY OF MERCHANTABILITY OR WARRANTY OF FITNESS FOR A PARTICULAR PURPOSE.

Graco's sole obligation and buyer's sole remedy for any breach of warranty shall be as set forth above. The buyer agrees that no other remedy (including, but not limited to, incidental or consequential damages for lost profits, lost sales, injury to person or property, or any other incidental or consequential loss) shall be available. Any action for breach of warranty must be brought within one (1) year past the warranty period, or two (2) years for all other parts.

GRACO MAKES NO WARRANTY, AND DISCLAIMS ALL IMPLIED WARRANTIES OF MERCHANTABILITY AND FITNESS FOR A PARTICULAR PURPOSE, IN CONNECTION WITH ACCESSORIES, EQUIPMENT, MATERIALS OR COMPONENTS SOLD BUT NOT MANUFACTURED BY GRACO. These items sold, but not manufactured by Graco (such as electric motors, switches, hose, etc.), are subject to the warranty, if any, of their manufacturer. Graco will provide purchaser with reasonable assistance in making any claim for breach of these warranties.

In no event will Graco be liable for indirect, incidental, special or consequential damages resulting from Graco supplying equipment hereunder, or the furnishing, performance, or use of any products or other goods sold hereto, whether due to a breach of contract, breach of warranty, the negligence of Graco, or otherwise.

FOR GRACO CANADA CUSTOMERS

The Parties acknowledge that they have required that the present document, as well as all documents, notices and legal proceedings entered into, given or instituted pursuant hereto or relating directly or indirectly hereto, be drawn up in English. Les parties reconnaissent avoir convenu que la rédaction du présente document sera en Anglais, ainsi que tous documents, avis et procédures judiciaires exécutés, donnés ou intentés, à la suite de ou en rapport, directement ou indirectement, avec les procédures concernées.

Graco Information

For the latest information about Graco products, visit www.graco.com.

TO PLACE AN ORDER, contact your Graco distributor or call to identify the nearest distributor.

Phone: 612-623-6928 or **Toll Free:** 1-800-533-9655, **Fax:** 612-378-3590.

All written and visual data contained in this document reflects the latest product information available at the time of publication. Graco reserves the right to make changes at any time without notice.

For patent information, see www.graco.com/patents.

Original instructions. This manual contains English. MM 312668

Graco Headquarters: Minneapolis
International Offices: Belgium, China, Japan, Korea

GRACO INC. AND SUBSIDIARIES • P.O. BOX 1441 • MINNEAPOLIS MN 55440-1441 • USA

Copyright 2008, Graco Inc. All Graco manufacturing locations are registered to ISO 9001.

www.graco.com
Revised May 2016